

Basketball Drills

- Drill 01 - Bull In The Ring
- Drill 02 - Bump The Cutter
- Drill 03 - Chill Drill
- Drill 04 - Close Out Drill
- Drill 05 - Defensive Shuffle And Pass
- Drill 06 - Fifty Passes
- Drill 07 - Five Corner Passing
- Drill 08 - Five On Four Plus One
- Drill 09 - Four On Four Recover
- Drill 10 - Full Court Four Line Passing
- Drill 11 - Full Court Lay-ups With Chaser
- Drill 12 - Full Court Lay-ups
- Drill 13 - Horseshoe Shooting
- Drill 14 - Knockout
- Drill 15 - Lay-up And Rebounding Lines
- Drill 16 - Line Dribbling Drills
- Drill 17 - Line Running Drills
- Drill 18 - Mass Defensive Drill
- Drill 19 - Mirror Drills
- Drill 20 - Motion Offense - Ball Reversal, Receivers
- Drill 21 - Motion Offense - Cutting To Get Open
- Drill 22 - Motion Offense - Dribble Entries
- Drill 23 - Motion Offense - Give And Go
- Drill 24 - Motion Offense - Perimeter To Post
- Drill 25 - Motion Offense - Post Players
- Drill 26 - Motion Offense - Screen And Roll
- Drill 27 - Motion Offense - Screen Away
- Drill 28 - Mushball
- Drill 29 - One On One
- Drill 30 - Pass, Shoot And Rebound
- Drill 31 - Pass, Shoot, Box Out
- Drill 32 - Penetrate And Dish
- Drill 33 - Pepper Drill
- Drill 34 - Pig In The Middle
- Drill 35 - Pivot Away, Two On One
- Drill 36 - Post Moves
- Drill 37 - Power Post Pickups
- Drill 38 - Pride Drill
- Drill 39 - Shell Drill
- Drill 40 - Slide Run Slide
- Drill 41 - Star Drill
- Drill 42 - Ten Fingers
- Drill 43 - Terminator
- Drill 44 - Three On Two, Two On One
- Drill 45 - Three-Man Weave
- Drill 46 - Turning And Channeling The Dribbler
- Drill 47 - Two Teams Sliding
- Drill 48 - Cincinatti
- Drill 49 - Create A Lead
- Drill 50 - Dribble, Cut, Pass & Drive
- Drill 51 - Half Court, Two Pass Drill
- Drill 52 - Triangle Passing
- Drill 53 - Triangle Shooting

Basketball Drill

Drill Number: 01 **Name:** Bull In The Ring
Type: Passing, Defense

Description:

Players form a circle around a single defender.

Players in the circle must make passes to others in the circle, but may not pass to a player next to them.

The defender must pressure the player with the ball and attempt to intercept or "touch" the pass.

On an interception or "touch" the passer replaces the defender in the middle.

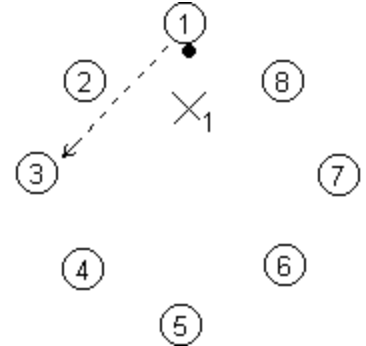

Variations:

1. Use two or more balls.
2. Use two or more defenders in the circle.
3. Change size of circle for shorter or longer passes.
4. Put a time limit on ball-handler to get off pass (e.g. defender counts to 3 seconds).

Points of Emphasis:

1. Fake a pass to make a pass.
2. Tough defense on the ball, don't just sag off ball.
3. Active hands.
4. No lollipop passes over the top of the defender.

Basketball Drill

Drill Number: 02 **Name:** Bump The Cutter
Type: Defense

Description:

Coach has ball outside three-point line. Offensive player starts in opposite corner.

Defender adopts flat triangle position in key.

Offense attempts flash cut to ball.

Defender must meet cutter in lane, bump the cutter and deny the pass in the key, forcing the offense out to a less advantageous position low in the opposite corner or high on top.

If offense gets ball, play one on one to basket (offense has no more than two dribbles).

Rotate offense to defense.

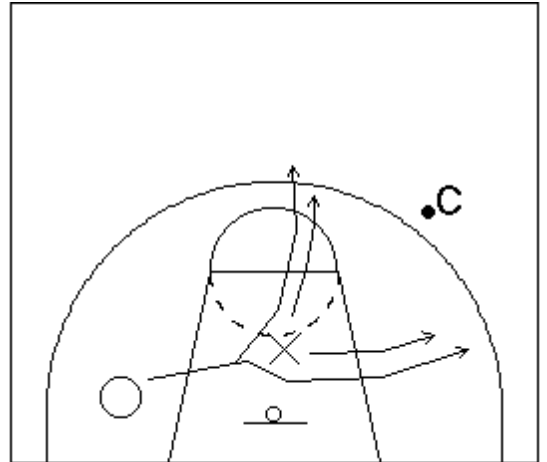

Variations:

Reposition feeder (coach) and cutter to various parts of offensive half-court.

Points of Emphasis:

1. Defense adopt correct initial position relative to ball and man.
2. See ball and man.
3. Deny the pass in the key.
4. Contact the cutter (chest or arm bar).
5. Deny stance up high, snap head and arm down low.
6. Defense lower than offense - correct stance.
7. Correct footwork.

Basketball Drill

Drill Number: 03 **Name:** Chill Drill
Type: Dribbling

Description:

Players line up at corner of the court and follow the path shown in diagram to the right.

The following describes the desired path.

Dribbler starts at corner with ball in right hand.

1. At points A and B execute an inside-out move (fake crossover).
2. At point C execute a reverse spin - now dribbling left hand.
3. Dribble to point D, then quickly retreat dribble back to point E.
4. At point E, execute a quick, low crossover dribble and dribble to point F - now dribbling right hand.
5. At point F execute a 180 degree half spin (fake reverse).
6. At point G execute a behind-the-back as you change direction.
7. At point H execute a hesitation, stutter-step dribble and explode to the basket for a lay-up.

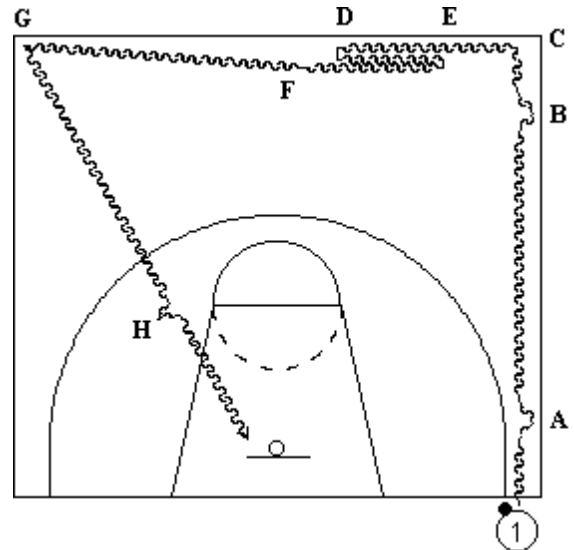

Variations:

Go around the opposite direction (start at bottom left corner).

The other variations you can make to this drill are limited only by your imagination.

Points of Emphasis:

1. Keep your head up - see the court.
2. Low dribbling stance.
3. Explosive, quick moves.
4. Do it at game pace.
5. Low dribbles (especially on crossovers).

Basketball Drill

Drill Number: 04 **Name:** Close Out Drill
Type: Defense

Description:

Four players set up around three point line. Remaining players in line underneath basket.

No ball is used in this drill.

X1 "closes out" player 1. Player 1 makes an offensive move (only one step required, but direction should be varied) and X1 must drop step in that direction and make one quick slide.

X1 then retreats back to basket and repeats action for the other three players around three point line.

X2 can start and perform same action once X1 has finished with player 1.

Once X1 is back at start of line players 1-4 rotate (4 goes to Xs line and X1 replaces player 1).

Variations:

Practice both "bunny hop" and "stutter step" close out methods.

Points of Emphasis:

1. Correct defensive stance and footwork.
2. Defender calls "ball" every time.
3. Offense use proper triple threat stance and correct jab footwork.

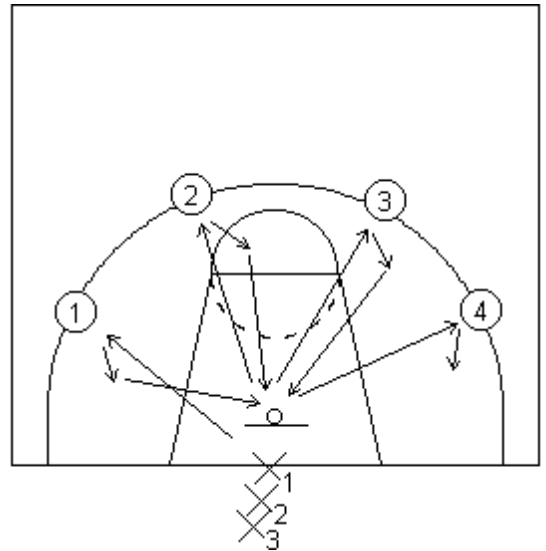

Basketball Drill

Drill Number: 05

Name: Defensive Shuffle And Pass

Type: Defensive Stance, Footwork and Passing

Description:

Players are in groups of three.

The three players set up as shown in diagram A. Two players with balls are about 3-4 steps apart and face third player who begins drill standing in front of one of the other players.

Player 1 passes to player 3 who returns pass and then defensive shuffles in front of player 2 (diagram A). Player 2 then passes to player 3 who returns pass and then defensive shuffles back in front of player 1 (diagram B). This sequence is repeated.

Run for specified time (e.g. 1 minute) and rotate players.

Variations:

1. Specify types of passes to be made.
2. Most passes in specified time (competitive).

Points of Emphasis:

1. Correct defensive footwork (wide then wider).
2. Good crisp passes.

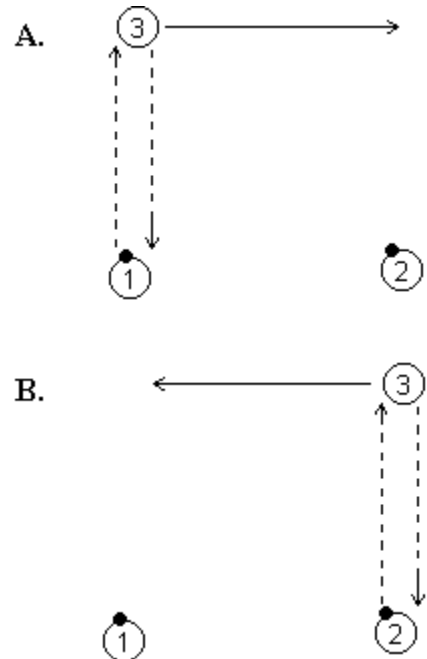

Basketball Drill

Drill Number: 06

Name: Fifty Passes

Type: Passing, Moving Without The Ball, Defense

Description:

Split group into two teams (of equal ability).

Players use half-court.

Players are not allowed to dribble the ball.

Each team must try to complete fifty passes to win the game. Each team counts out loud as they complete each pass.

Possession always changes to other team when a violation (or dribble) occurs, or the ball is held or the ball goes out of bounds (irrespective of who it came off when it went out).

When a team gets possession back they continue pass count from where they got to on last possession. First team to fifty wins the game.

Variations:

None.

Points of Emphasis:

1. Fake a pass to make a pass.
2. Move to space - create a passing lane.
3. Move to the ball - don't wait for it.
4. Pivot and move ball aggressively when confronted by defender(s).
5. Step into defender to make a pass.
6. Vary the type of passes you make - don't be predictable.
7. Talk - communicate.
8. On defense - man up !

Basketball Drill

Drill Number: 07 **Name:** Five Corner Passing
Type: Passing

Description:

Players form five lines in a star alignment (see diagram).

Players in front of two lines have balls.

The players must pass to the player in the front of the line that is next-but-one to them. They must then follow their pass to the end of that line.

Instruct players to run to the far side of the line they are joining. This creates more traffic for the next passer.

Variations:

1. For beginning players start off with just one ball.
2. Specify the type of passes to be made.
3. On coaches shout of "reverse" players must reverse the direction of passes (i.e. anti-clockwise to clockwise).

Points of Emphasis:

1. Communicate - call a name.
2. Show ten fingers.
3. Step to the ball to receive the pass.
4. Good passing form.
5. Good crisp passes.

A.

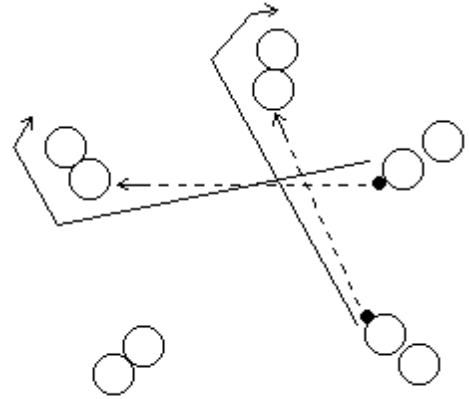

B.

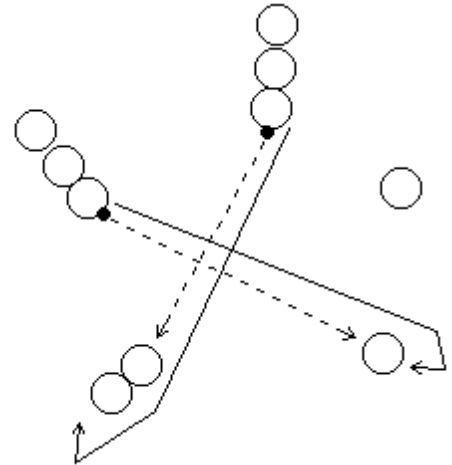

Basketball Drill

Drill Number: 08 **Name:** Five On Four Plus One
Type: Transition.

Description:

Offense lines up along baseline.

Defense lines up along free-throw line extended.

Coach passes ball to one of the offensive players and offensive team go straight into offensive transition.

The defensive player guarding the offensive player who received the ball must sprint and touch the baseline before joining the team on defense.

Variations:

None.

Points of Emphasis:

1. Defense must sprint back, get behind ball.
2. Get back and protect the basket.
3. Someone must take the ball-handler.
4. Communicate, communicate, communicate.

A.

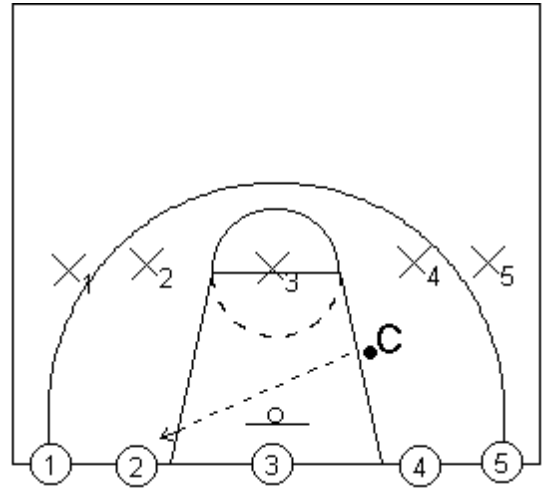

B.

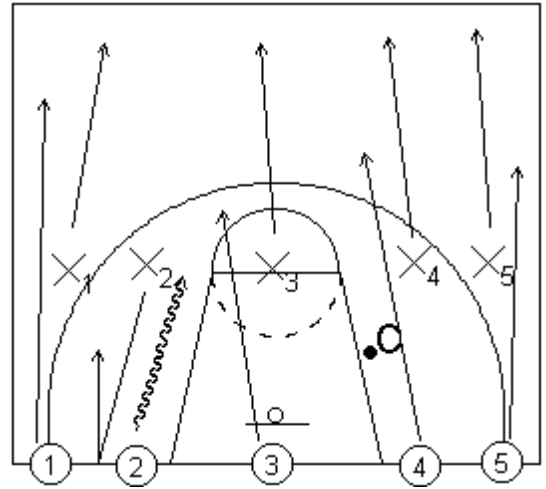

Basketball Drill

Drill Number: 10 **Name:** Full Court Four Line Passing
Type: Passing, Transition

Description:

Players get into four lines at baseline as shown in diagram.

Players progress the ball down the court by passing and moving in their lines only.

Note that to create traffic and make job harder, players in line 1 are passing across to line 3 and back. Players in line 2 are passing to line 4 and back.

As players get to free-throw line extended at opposite end outside players cut to basket for pass and lay-up.

Inside and outside players exchange lines and players return back down court in similar fashion.

Variations:

For younger players you may decide to make it easier and remove the traffic option and have players pass to lines next to them.

Alternatively, you might like to have lines 1 and 4 exchange longer passes and lines 2 & 3 exchanges shorter ones.

Points of Emphasis:

1. Do it a full speed, on the run, not stop and go.
2. Pass in front of a moving player.
3. Show ten fingers and call a name to receive pass.

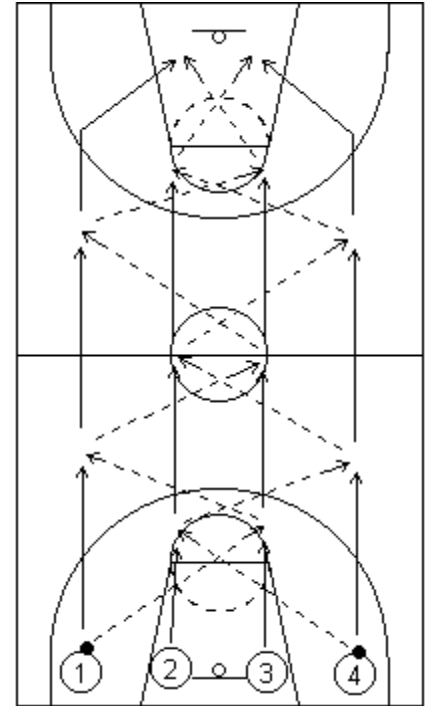

Basketball Drill

Drill Number: 11 **Name:** Full Court Lay-ups With Chaser
Type: Transition, Lay-ups

Description:

Players make two lines (one under basket, one at right corner of court).
Players in centre line have ball each.

Player 1 (centre line) throws ball at backboard and rebounds. Player 2
(corner line) assumes outlet position.

Player 1 passes to player 2 who speed dribbles for a lay-up. Player 1 chases
in attempt to distract or block the lay-up.

At other end players swap roles and come back on the other side of the
court.

Variations:

1. See how few dribbles any pair can make for two baskets.
2. How many baskets can team make in certain time.

Points of Emphasis:

1. Speed dribble - push the ball out in front.
2. Sprint.
3. Correct lay-up form.
4. Don't rush the lay-up.
5. Outlet player in "knife" position - back to sideline, see the whole court.

A.

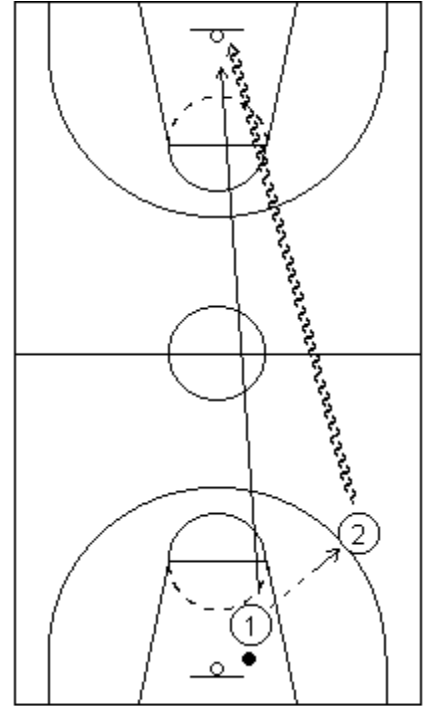

B.

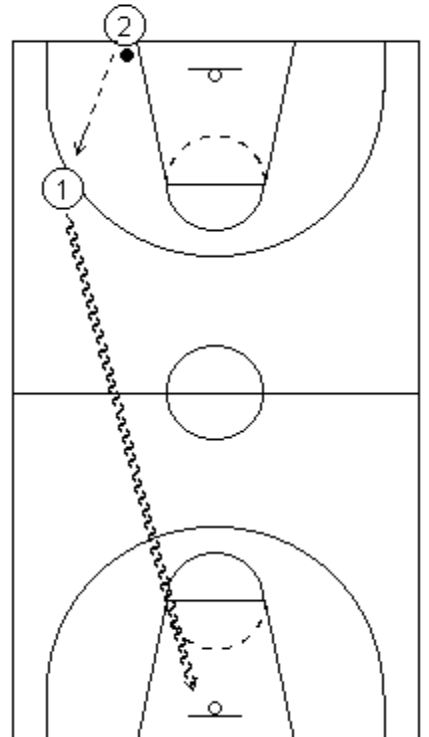

Basketball Drill

Drill Number: 12 **Name:** Full Court Lay-ups
Type: Transition

Description:

Players form three lines at baseline.

A cone or chair is placed on court at opposite end on three-point line at free-throw line extended.

On way down court, player 1 sprints the lane and goes outside the cone and cuts to the basket, timing run for pass from other two players who are passing the ball down the court whilst running in their lanes (see diagram A). Player 1 scores with a lay-up.

Middle lane (player 2) rebounds the ball while outside players exchange lanes. Player 3 runs outside the cone, and runs the outside lane looking for pass from the other two players (see diagram B). Player 3 scores with a lay-up.

Players join end of a different line and drill continues.

Variations:

1. Create traffic and heads-up play by starting second and subsequent groups when previous group scores.
2. Time players (how many scores in set time period e.g. two minutes) - have a team record that you constantly try and beat each time.

Points of Emphasis:

1. Teamwork - timing, communication, effort.
2. Transition - sprint the drill.
3. Pass in front of a moving player.
4. Ball does not hit the floor for entire drill.

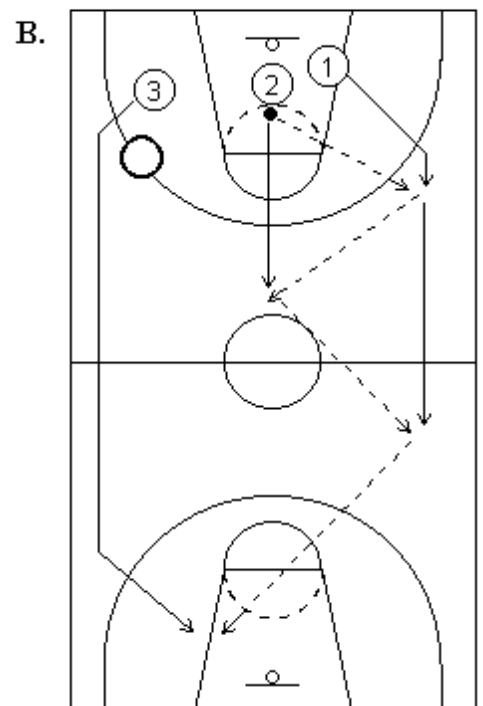
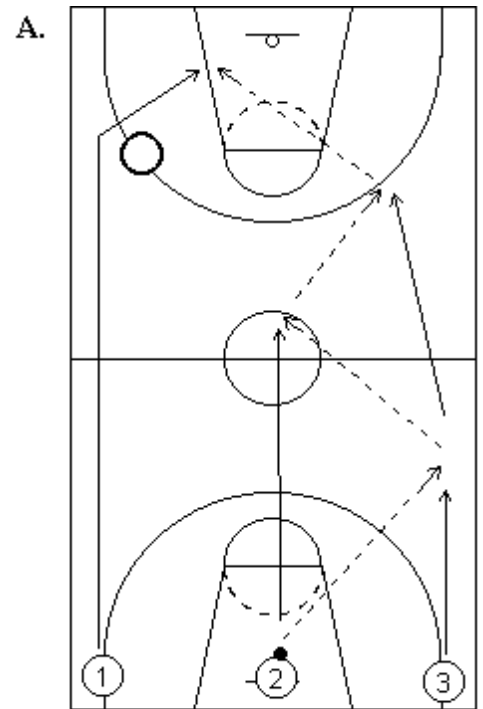

Basketball Drill

Drill Number: 13 **Name:** Horseshoe Shooting
Type: Shooting, passing / receiving

Description:

Players form two lines on baseline at either side of the key. The first player in one line has a ball, the second player in the other line has a ball. The coach stands on the middle of the free-throw line.

Player 2 (front of line without ball) makes a v-cut around the coach, calling for the ball from player 1. Player 1 passes the ball to player 2 who shoots the basket and rebounds the ball. After taking the rebound players pass to the front player in the opposite line (opposite to where they came from). They then join the end of this line.

After passing the ball, the player cuts around the coach as described above and the drill continues.

Variations:

1. Take a dribble after receiving the ball and shoot off the dribble.
2. Make a hard drive to the basket rather than the shot.
3. Add a shot fake before the shot.

Points of Emphasis:

1. Correct footwork on the cut and good hard change of direction.
2. Receive the ball in the triple threat position ready to shoot.
3. Correct shooting form.
4. Communicate - call for the ball.

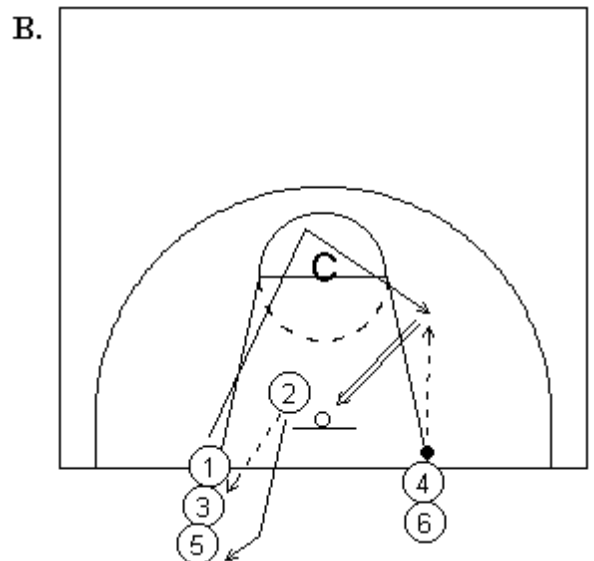
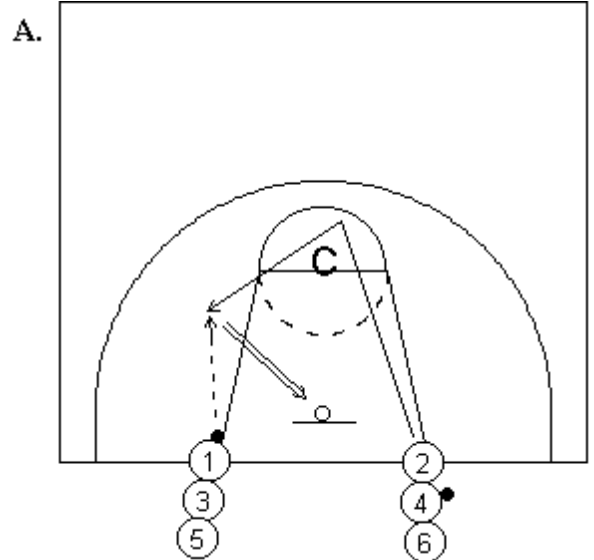

Basketball Drill

Drill Number: 14 **Name:** Knockout
Type: Shooting

Description:

Players form line at free-throw line with first two players having a ball.

Players shoot their first shot from free-throw line and if they miss they follow their shot and keep rebounding and shooting until they score.

Once the player in front of you has shot, you can begin in the same fashion as described above. If the player behind you scores before you do you are out of the game.

Once you score, rebound the ball and return to next player in line, then return to end of line.

Last player left in wins the game.

Variations:

First shot from different position (e.g. 45 degrees, three-point line).

Points of Emphasis:

1. Correct shooting form.
2. Observe free-throw rules - don't follow shot until ball hits ring.
3. Strong rebounding.
4. No travels when going to basket on missed shots.

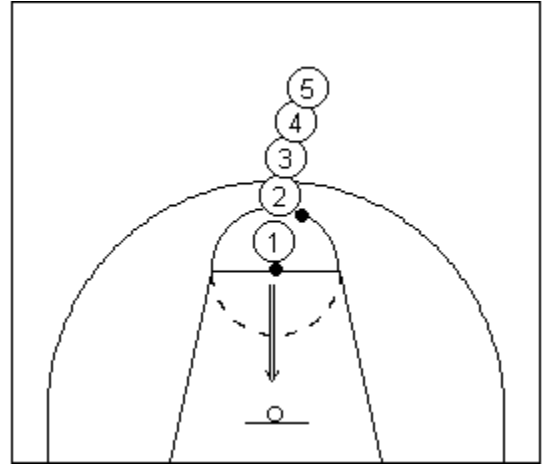

Basketball Drill

Drill Number: 15 **Name:** Lay-up And Rebounding Lines
Type: Lay-ups, rebounding, passing

Description:

Players make two lines. The lay-up line is well outside the three point line towards the sideline. The rebound line is on the opposite side of the court at about the three point line. The first person in the lay-up line has a ball.

Players in lay-up line make hard drives to the basket for a lay-up.

Rebounder moves to basket anticipating rebound and takes strong rebound.

Player who took lay-up moves to end of rebound line.

Rebounder takes two strong dribbles out, make a good pass to next player in lay-up line and then move to the end of the lay-up line.

Variations:

1. Swap sides of court.
2. Increase number of balls (up to as many as number of players will allow).
3. Vary type of lay-up (e.g. reverse, two-foot stop into power lay-up etc.)

Points of Emphasis:

1. Correct lay-up form.
2. Make it a hard drive to basket (game speed).
3. Ball does not hit floor on the rebound.
4. Strong rebound, protect ball, strong dribble, hard pass.
5. Receiver to receive the ball running to the basket, not standing still.

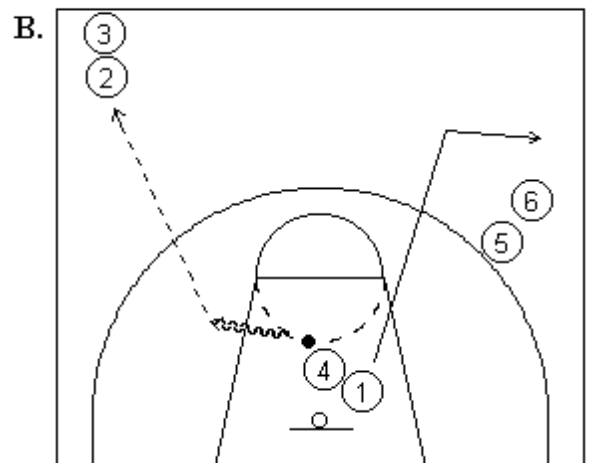
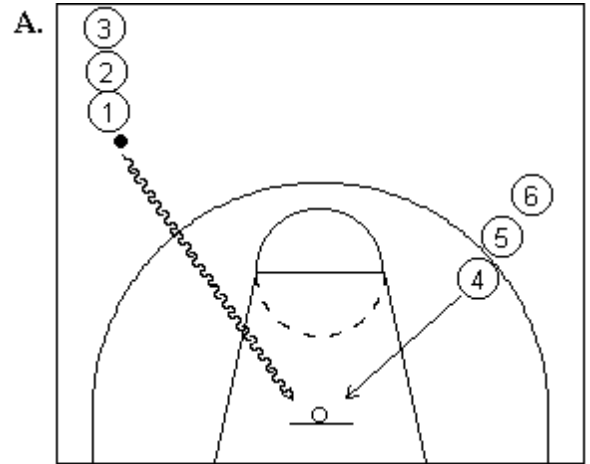

Basketball Drill

Drill Number: 16 **Name:** Line Dribbling Drills
Type: Dribbling

Description:

For straight line drills players line up in four lines at baseline (see diagram A).

Players dribble down the court, and at designated spots (e.g. free-throw line extended, centre line), or on whistle, make one of the following designated moves;

1. Change from speed dribble to control (protection) dribble.
2. Crossover.
3. Fake crossover (inside out).
4. Reverse dribble.
5. Stutter (hesitation) dribble.

For change of direction drills players line up in two lines near centre of court. Players practice change of direction dribbles in a zig-zag pattern down court (see diagram B). They can make one of the following designated moves.

1. Crossover.
2. Behind the back.
3. Between the legs.

Variations:

Follow the leader - all players follow moves of designated player.

Points of Emphasis:

1. Head up - see the court.
2. Correct dribbling technique - fingertips not palms.
3. Protect the ball.
4. Footwork.
5. Balance.
6. Stay low.
7. Explosive change of direction - plant the foot and push off.

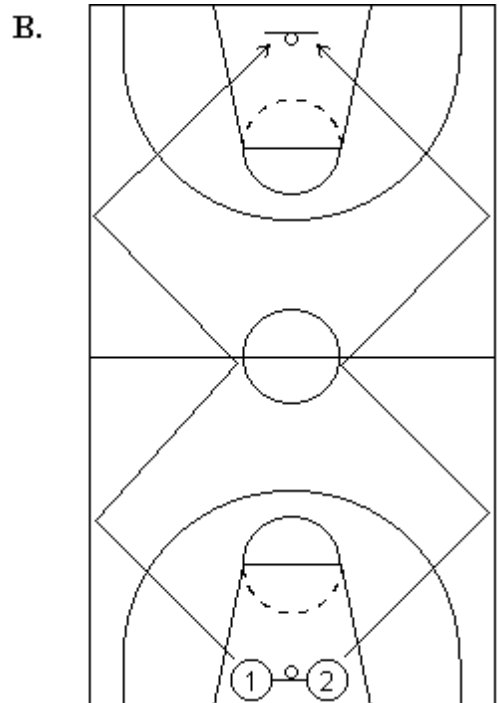
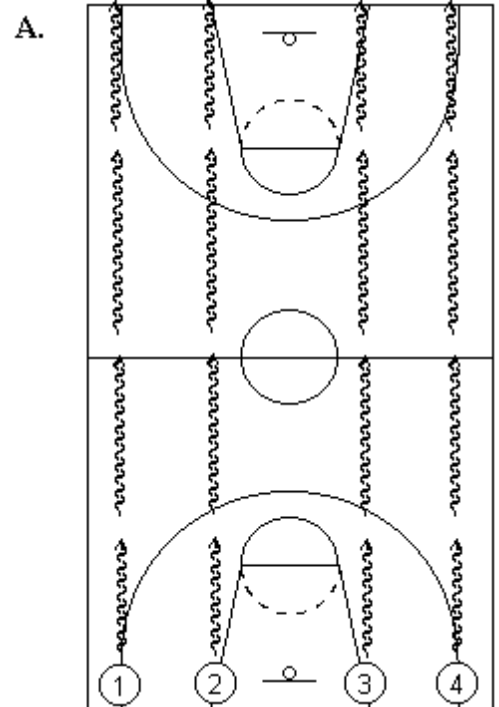

Basketball Drill

Drill Number: 17 **Name:** Line Running Drills
Type: Body movement fundamentals

Description:

For straight line drills players line up in four lines at baseline (see diagram A).

Players run down the court using one of the following designated running styles,

1. Normal jog.
2. Heels high jog.
3. Knees high jog.
4. Grapevine.

In addition, at designated spots (e.g. free-throw line extended, centre line), or on whistle, make one of the following designated moves,

1. Jump stop.
2. Stride stop.
3. Forward pivot.
4. Reverse pivot.
5. Stutter (hesitation) step.

For change of direction drills players line up in two lines near centre of court. Players practice change of direction in a zig-zag pattern down court (see diagram B).

Variations:

Follow the leader - all players follow moves of designated player.

Points of Emphasis:

1. Footwork.
2. Balance.
3. Stay low.
4. Explosive change of direction - plant the foot and push off.

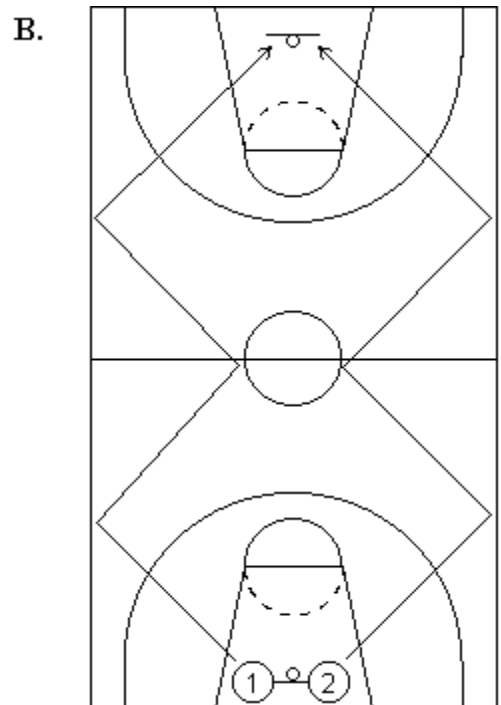
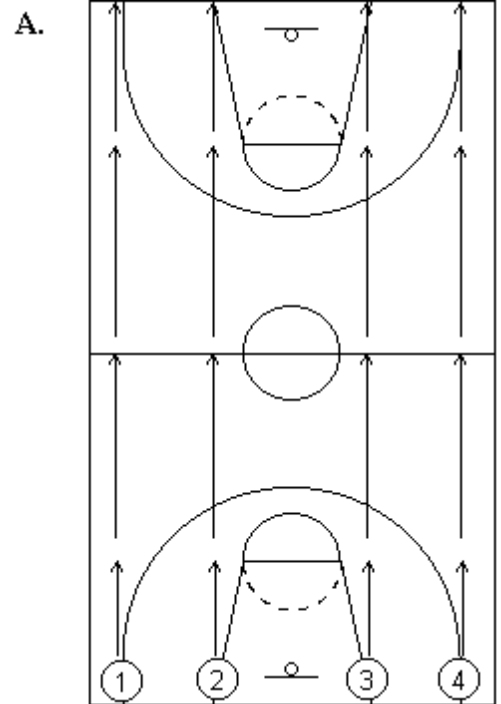

Basketball Drill

Drill Number: 18 **Name:** Mass Defensive Drill
Type: Defensive stance and footwork.

Description:

Players spread out on court facing the coach who is standing in front of them.

The coach can use visual or audible cues to make the players do the following;

1. Get into their defensive stance.
2. Footfire or pitter-patter with their feet (conditioning).
3. Defensive footwork any direction (e.g. left or right slide, drop-step and slide, retreat step, close out).
4. Change hand position - coach might move ball around and have players trace ball, challenge shot etc.

Visual cues may be better as it encourages players to keep their heads up.

Variations:

Have a player lead the others.

Points of Emphasis:

1. Correct defensive stance.
2. Stay low - no bobbing up and down.
3. Keep head in middle of body.
4. Keep head back - "nose behind toes".
5. Correct defensive footwork - wide then wider - don't bring feet together.
6. Active hands.

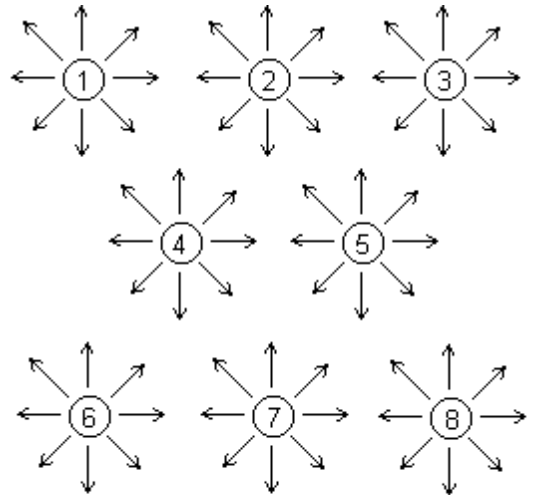

Coach

Basketball Drill

Drill Number: 19 **Name:** Mirror Drills
Type: Defense

Description:

This drill is designed to allow the players to improve their defensive stance and footwork.

It can be run in one of two ways.

1. Players line up in a straight line facing towards the coach who is standing in front of them (see diagram A).

As the coach moves from side to side the players attempt to keep with him and in a line.

2. Have players pair up and each pair chooses a line on the court.

One player moves laterally along the line whilst the other player (facing them) attempts to stay in front of them (like "looking in a mirror").

Limit the number of steps to three before a change of direction or it will just turn into a running race along the line.

After 30 seconds players swap roles (leader - follower).

A.

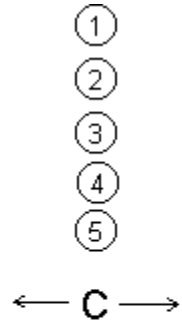

B.

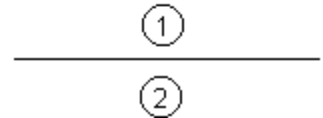

Variations:

None.

Points of Emphasis:

1. Correct stance and footwork (wide then wider).
2. Quickness.

Basketball Drill

Drill Number: 20 **Name:** Motion Offense - Ball Reversal, Receivers
Type: Motion Offense

Description:

These drills are designed to practice and teach the value of quick ball reversal. We also teach the principle of having two receivers in position when dribble penetration occurs into the key.

Drill A (diagram A) has three players one at each wing and one at point. Players pass the ball point - wing - point - wing with each player v-cutting and replacing themselves after they make each pass.

Diagram B shows the four areas we want our players to get to, to be effective, threatening receivers when one of their team-mates dribble penetrates into the key. Every time the ball is dribbled into the key we want two of these spots filled. If the penetration is above the blocks it is both low spots that should be filled. If penetration is below the block fill one high spot and low spot opposite the penetration.

Diagram C shows the progression from drill A. After a certain number of reversal passes coach shouts drive and ball-handler penetrates with their dribble, other two offensive players must move to the receivers spots for a pass off and score.

Diagram D shows another set-up for similar drill with defender X3 helping and being forced to close out after quick ball reversal. O3 fakes / jabs and drives, O1 and O2 again must move to receivers spots.

Variations:

1. Drill A is good to run competitively - groups of 3 most passes in specified time. Don't count a pass if v-cut not done correctly.
2. All drills should be done 3 on 0 to start and then progress to 3 on 3.
3. Start with token defense moving to full 3 on 3.

Points of Emphasis:

1. Quick ball reversal.
2. V-cuts - plant foot, good change of direction, target hand.
3. Passes - pass away from defender.
4. Catch and square up to the basket.
5. Receivers - get to spots and present a target.
6. Recognise space - move into space.
7. Five player receivers principle - one player penetrating, two players in receivers spots, one player spotting up for outside shot, one player is defensive safety.

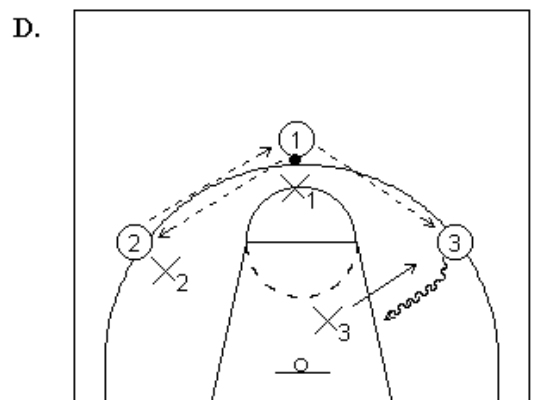
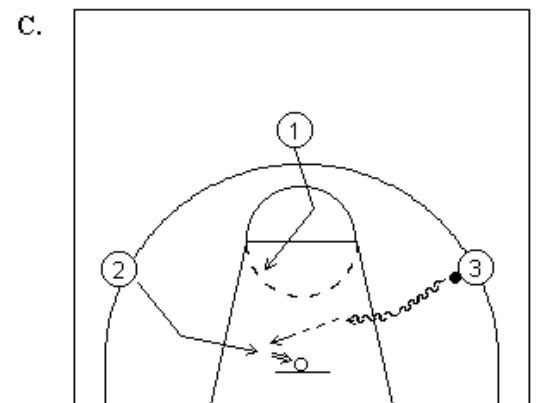
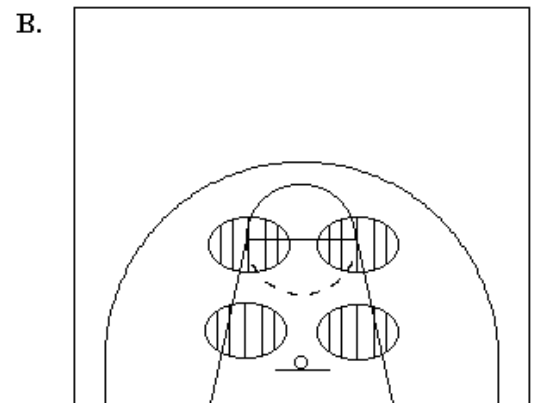
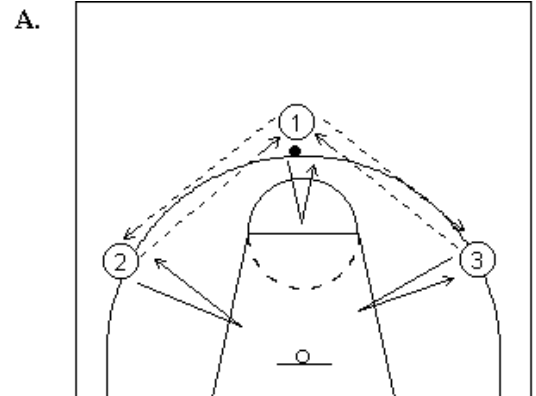

Basketball Drill

Drill Number: 21 **Name:** Motion Offense - Cutting To Get Open
Type: Motion Offense

Description:

These drills are used to teach the v-cut, backdoor cut and leading from the low post.

Diagram A shows v-cut.

Diagram B shows backdoor cut.

Diagram C shows leading from the post.

Variations:

1. Start all drills 2 on 0 and progress to 2 on 2.
2. Start with token defense moving to full 2 on 2.
3. Run from different parts of the floor.

Points of Emphasis:

- 1) Offense
 - a) At least two steps to take defender away.
 - b) Plant foot - push off - change direction quickly.
 - c) Present target hand.
 - d) Catch and square up to the basket.
 - e) Read the defense - e.g. if overplayed go backdoor.
 - f) Leading from post - take player up lane, inside leg and arm over in front of defender, once in front cut out to receive ball.
 - g) Pass into path of cutter - don't make him stop.
- 2) Defense
 - a) Defensive stance.
 - b) Correct defensive footwork.
 - c) Deny stance.
 - d) Jump to ball on pass - not after pass made.
 - e) Snap head and arm on backdoor cut.

A.

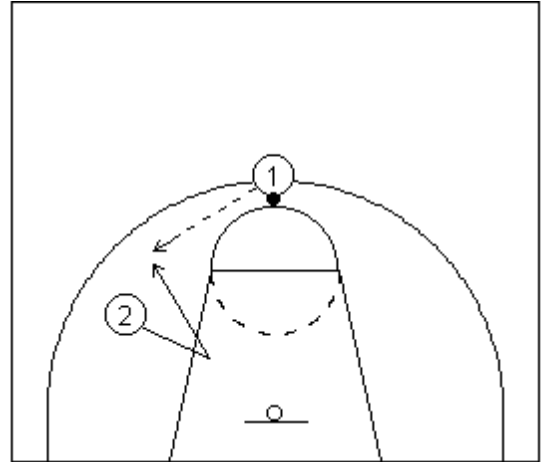

B.

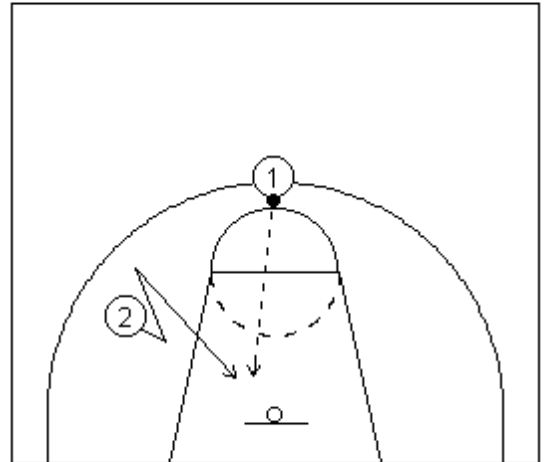

C.

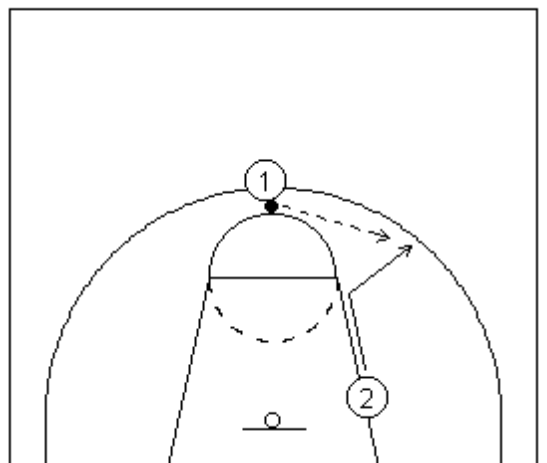

Basketball Drill

Drill Number: 22 **Name:** Motion Offense - Dribble Entries
Type: Motion Offense

Description:

Here we try to teach the different options available after a dribble entry to a wing.

Main teaching emphasis is on filling empty spots (recognising space and what your teammates are doing).

Diagram A shows a backdoor cut by O2 as she is dribbled at. O3 fills point (defensive safety) and O2 fills weakside if she doesn't get the pass. Run this drill with at least three return passes to new point before allowing pass to cutter. Obviously point can pass to either wing.

Diagram B shows post-up (button-hook) cut by O2. Again O3 fills point. Once defense is participating in drill, teach players to read how O2 is defended in post. If she is not fronted pass her the ball. If she is fronted pass to O3 at ballside elbow, O2 seals and looks for pass from O3.

Diagram C shows O2 making shallow cut and filling point. O3 moves her defender but replaces herself.

Variations:

1. All drills should be done 3 on 0 to start and then progress to 3 on 3.
2. Start with token defense moving to full 3 on 3.
3. Run from both sides of floor equally.

Points of Emphasis:

1. Moving to space.
2. Recognise teammates cuts.
3. Read defense.

A.

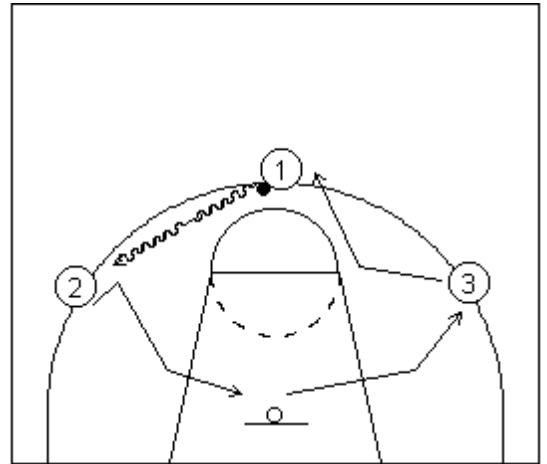

B.

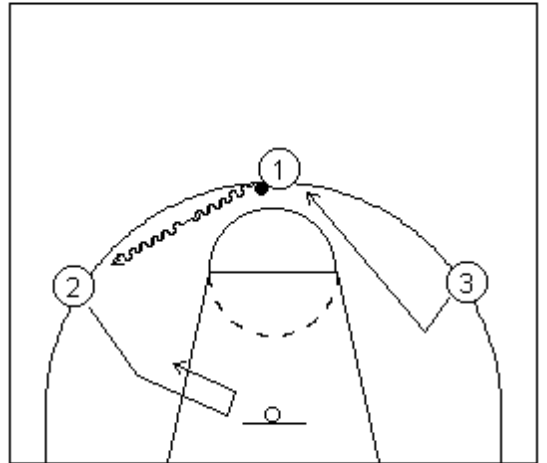

C.

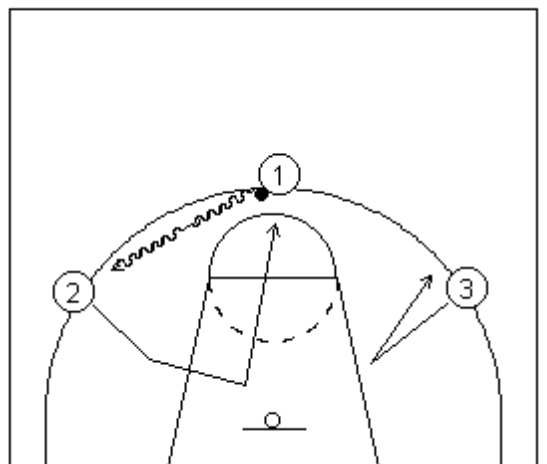

Basketball Drill

Drill Number: 23 **Name:** Motion Offense - Give And Go
Type: Motion Offense

Description:

These drills (along with many other variations) can be used to teach and practice the give-and-go.

In diagram A, O1 at point passes to a v-cutting O2 on wing and then cuts to basket.

In diagram B, O2 returns initial pass to O1 and runs backdoor cut for give-and-go.

In diagram C, O1 is running a give-and-go off the high post.

Variations:

1. All drills should be done 3 on 0 to start and then progress to 3 on 3.
2. Start with token defense moving to full 3 on 3.
3. Run from both sides of floor equally.

Points of Emphasis:

- 1) Offense
 - a) Good cuts.
 - b) Try for ballside cut whenever defense allows - take them away first to get ballside cut.
 - c) Target hand.
 - d) Bounce passes to cutter.
- 2) Defense
 - a) Defensive stance.
 - b) Correct defensive footwork.
 - c) Deny stance.
 - d) Jump to ball on pass - not after pass made.
 - e) Snap head and arm on backdoor cut.

A.

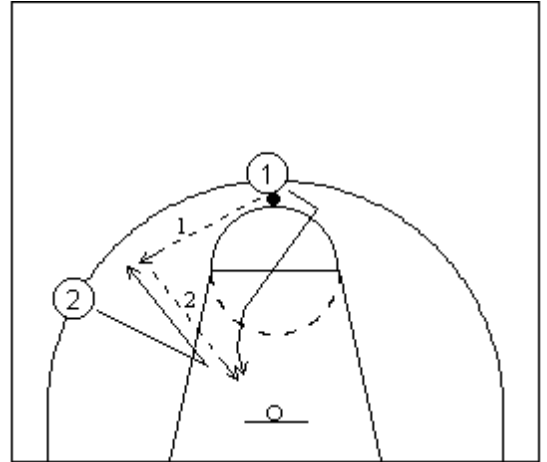

B.

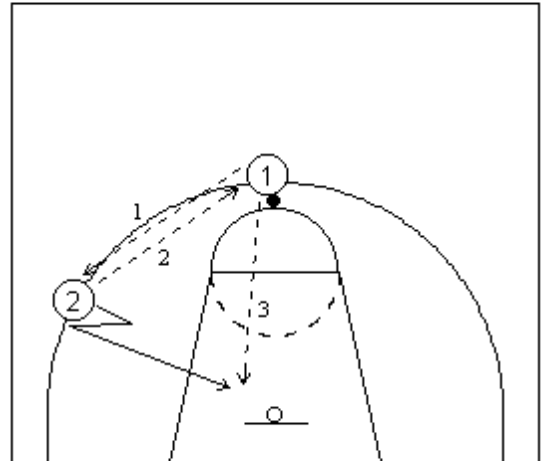

C.

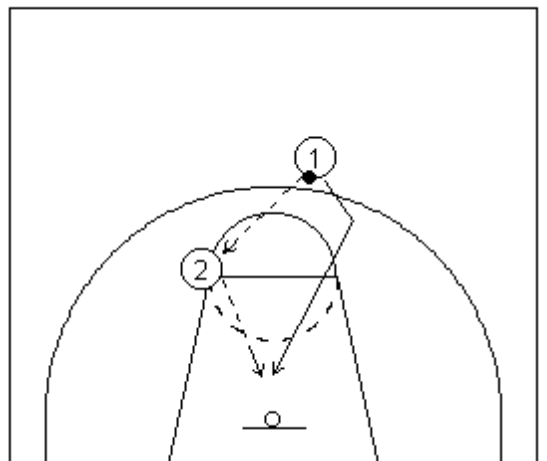

Basketball Drill

Drill Number: 24 **Name:** Motion Offense - Perimeter To Post
Type: Motion Offense

Description:

Run these drills to teach players to recognise how post players are defended and how to cut off posts.

In diagram A, pass is to high post, so wing O2 cuts low and O1 replaces O2.

In diagram B, pass is to low post, so point O1 cuts and O2 replaces O1.

In diagram C, post defense is allowing pass to post so we make it.

In diagram D, post defense is fronting so we pass to O1 cutting to ballside elbow, post seals and we look for high-low pass.

Variations:

1. Start 3 on 0, progress to 3 on 3.
2. Start with token defense progressing to full 3 on 3.

Points of Emphasis:

1. Recognise space.
2. Recognise open man.

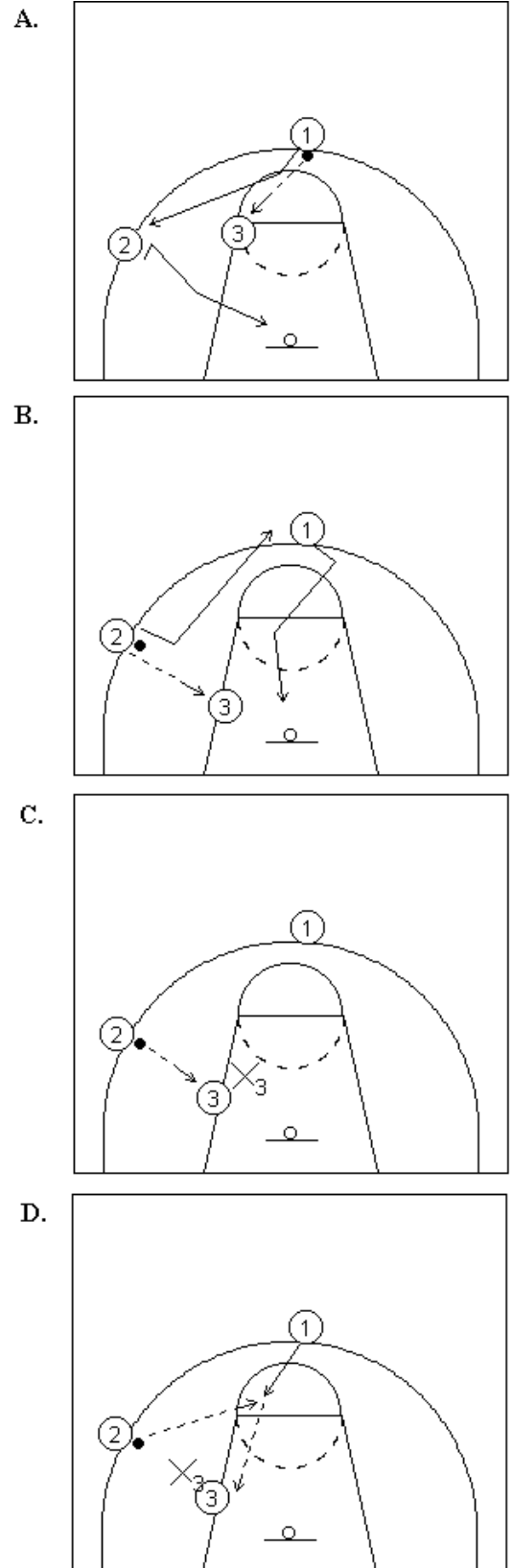

Basketball Drill

Drill Number: 25 **Name:** Motion Offense - Post Players
Type: Motion Offense

Description:

Here we teach two post players to work together.

We also teach defense on posts.

Diagram A, when pass is to high post, low post seals and looks for pass and basket.

Diagram B, when pass is to low post, high post shows and then cuts to basket looking for pass from low post and basket.

Diagram C shows a good drill I use where we have two posts and two post defenders. Remainder of squad passes ball around key looking for posts to make good position and they then pass to posts who go 2 on 2.

Diagram D shows a good two-passers to two posts drill. Posts set a screen and roll on cross screen and both screener and roller get pass for a basket.

Variations:

1. Start 3 on 0, progress to 3 on 3.
2. Start with token defense progressing to full 3 on 3.
3. Run from both sides of floor.
4. Various cuts off screens.

Points of Emphasis:

- 1) Offense.
 - a) Recognise how your partner is defended.
 - b) Remember to move without the ball - correctly.
 - c) Present a target when you want the ball by holding hand up and yelling for ball. Drop hand and stop yelling one second before moving (e.g. to screen or relocate). This way you won't get hit in the head by a pass from a teammate.
 - d) Jump stop as you receive the ball in the post - option of either foot as pivot foot.
 - e) Receiving the ball, remember the 3 C's. Catch, Chin (the ball, protect with extended elbows) and Check your defender.
- 2) Defense.
 - a) Side-front high when ball is high.
 - b) Side-front low when ball is low.
 - c) Correct footwork in front of post to move between two stances.

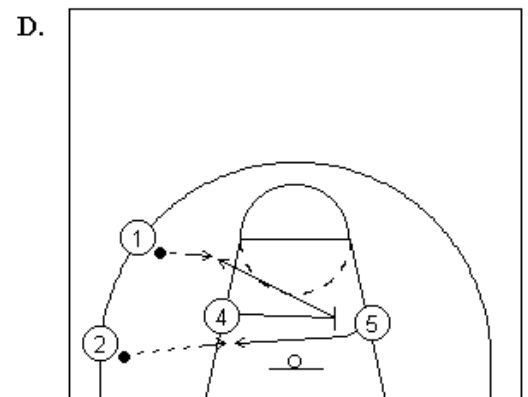
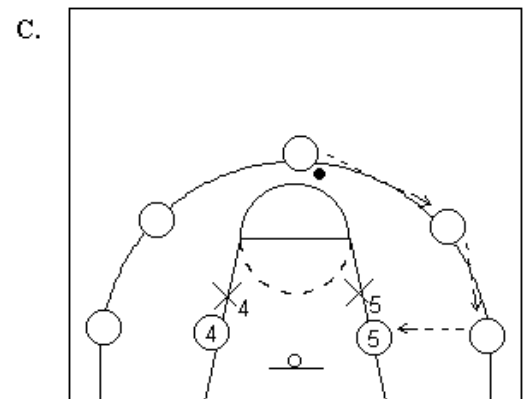
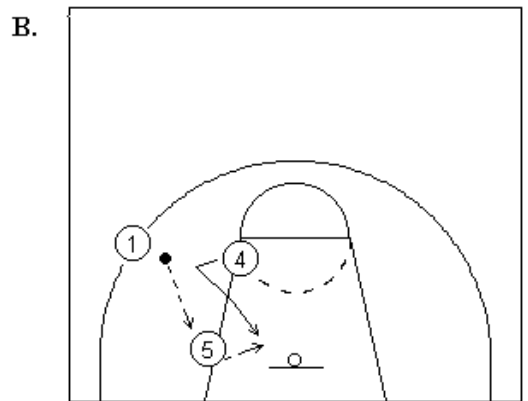
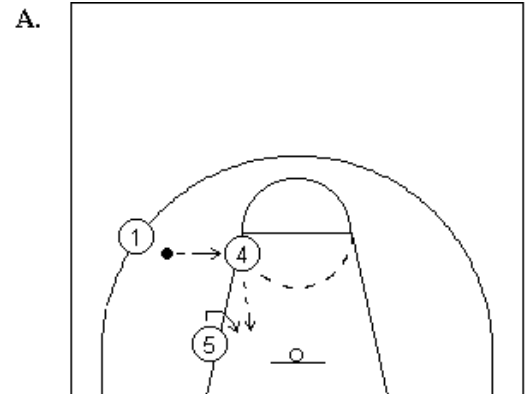

Basketball Drill

Drill Number: 26 **Name:** Motion Offense - Screen and Roll
Type: Motion Offense

Description:

These drills teach the screen and roll.

Point O1 passes to wing O2 and sets screen on O2s defender. O2 reads defense and drives off screen. O1 rolls to basket.

Variations:

Start 2 on 0, progressing to 2 on 2.
Start with token defense, move to full 2 on 2.

Points of Emphasis:

- 1) Offense.
 - a) Cutter must wait for screener to set.
 - b) Screener must set wide, low, balanced screen, arms in, make contact with defense.
 - c) Cutter uses screen - brush shoulders.
 - d) Drive hard, penetrate - look to score.
 - e) Screener rolls - see ball rule.
- 2) Defense.
 - a) Screeners defender must show numbers and recover.
 - b) Cutters defender must fight over top of screen (hips and leg over).

A.

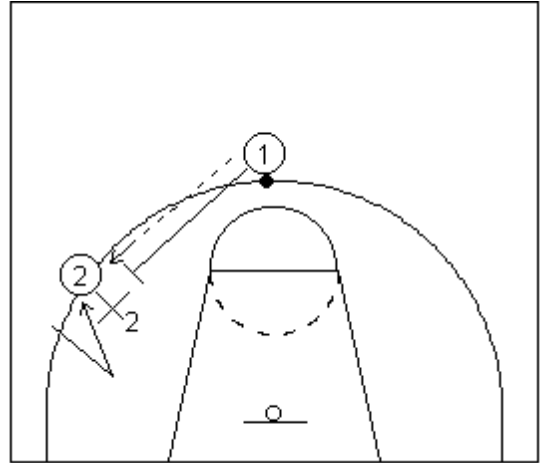

B.

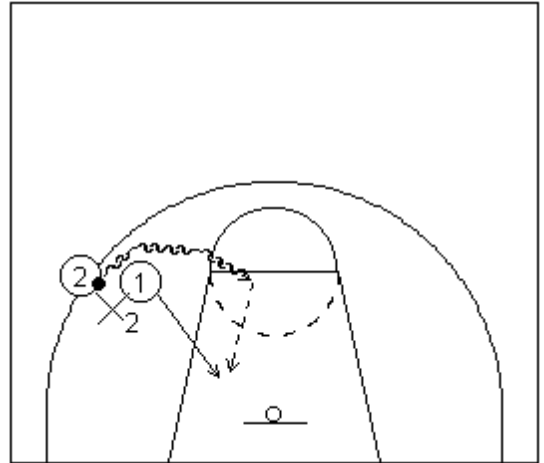

Basketball Drill

Drill Number: 27 **Name:** Motion Offense - Screen Away
Type: Motion Offense

Description:

These drills show how to begin teaching the screen away from the ball.

Diagram A shows point O1 passing to wing O2 and then setting screen weakside for O3.

Diagram B shows O3 cutting off screen and O1 rolling to basket.

Diagram C shows a modification to B where an extra passer is inserted to give both screener and cutter a pass and score.

Variations:

Start drills 3 on 0 and progress to 3 on 3.
 Start drills with token defense and move to full 3 on 3.

Points of Emphasis:

- 1) The player who is setting the screen should remember to,
 - a) Keep your feet shoulder width apart, bend your knees and take up a strong balanced position.
 - b) Hold your arms strongly across your chest to protect yourself.
 - c) Expect contact - you want the defender to run into you !
 - d) Make sure your body is positioned "square" to the direction you are trying to screen.
 - e) Make sure the defender is in the middle of your body.
 - f) Remember to call your team-mate so she knows you are screening. Remember the raised "fist".
 - g) You must not push the defender.
 - h) You must remain stationary, and in your "cylinder".
 - i) Once the "cutter" has gone, "roll" to the basket.
- 2) The player who is cutting off the screen should remember to,
 - a) Don't cut too soon. You must wait for the screener to have set the screen properly and to be stationary.
 - b) Fake in the opposite direction that you are going to cut to put the defender off balance.
 - c) Cut close to the screener ! Brush shoulders with them. If you leave a gap the defender may get through it !
 - d) "Read" the defense and make your move accordingly.
 - i) If the screener does a good job and the defender is run right into the screen, the cutter should make a tight cut, close to the screener, into the lane looking for a pass.
 - ii) If the defender gets between the screener and the cutter (fights over the top of the screen), the cutter can go back door looking for the pass. The screener should turn (face the basket) to block the defender.
 - iii) If the defender chooses to go behind the screener, the cutter pops out for an easy pass (and possibly a 3-point shot). Again the screener can turn to block the defender.
- 3) Correct screening angles.
 - a) Down screen - back to ball, b) Up screen - back to baseline corner, c) Back screen - back to basket, d) Cross screen - back to ballside elbow.

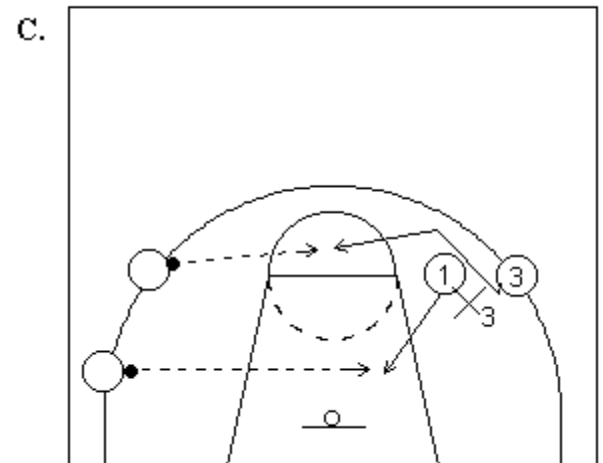
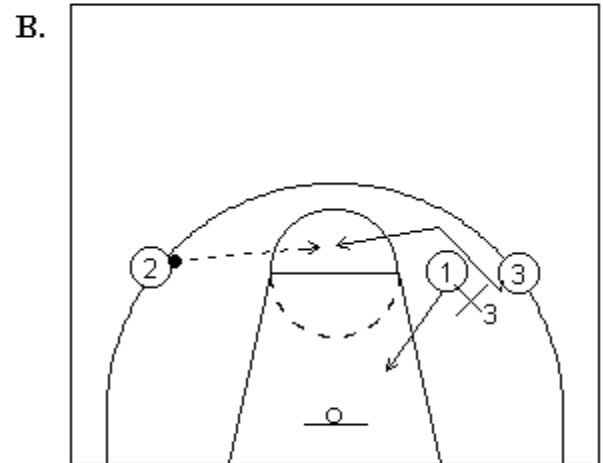
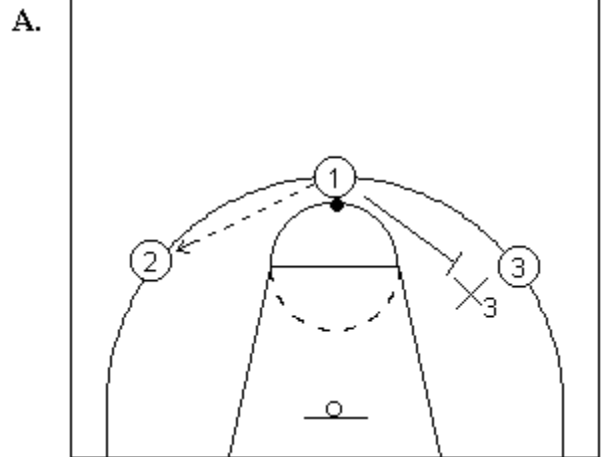

Basketball Drill

Drill Number: 28

Name: Mushball

Type: Free-throw shooting, offense/defense close to basket

Description:

Players line up as shown in diagram A. One player is in each of the low free-throw lane positions. The remaining players line up at the free-throw line with the first person in line with a ball.

The shooter shoots free-throws until she misses, scoring one point for each made shot.

Free-throw lane rules must be adhered to;

- players in the lane cannot cross line until ball leaves shooter's hand.
- shooter cannot cross free-throw line until ball hits ring.

On a miss all three players play to score. That is, the person who rebounds is on offense, the other two are on defense.

A field goal from this 1 on 2 contest is worth two points.

Players cannot go further than one step outside key.

Play continues until a field goal is scored, the ball leaves the field of play (i.e. one step outside of key), a violation occurs or the ball is held. Then players rotate. The rotation sequence is shown in diagram B.

Encourage strong moves to the basket, through the defense. There are no fouls (other than flagrant ones) in mushball.

Variations:

1. In the case where a player is well defended and cannot score, allow a pass out to the coach (who is standing to one side just inside the three-point line). The coach should return the ball to the same player, as long as she does a good job of getting open (by cutting to the basket, or posting up).
2. Allow players waiting in line to distract shooter by shouting etc. (no touching).
3. Have players rotating from second lane position run a suicide before returning to end of free-throw line. This should help simulate tiredness (e.g. end of game).

Points of Emphasis:

1. Players to have correct free-throw form and a consistent free-throw routine.
2. Players to go strong to basket (body parallel to backboard).
3. Read defenders and move accordingly.
4. Use the pump fake.
5. Go strong for the rebound.
6. Power dribble only - protect the ball.

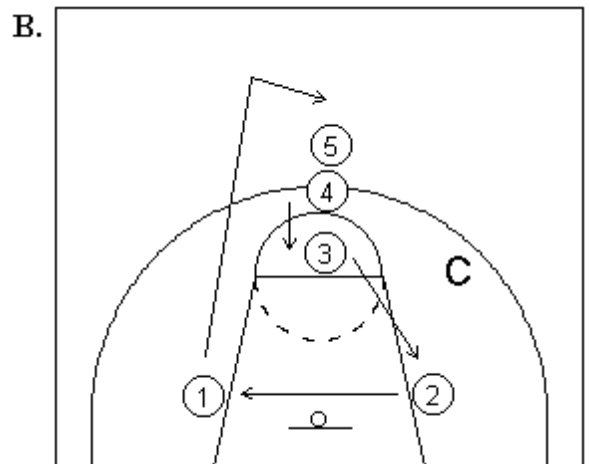
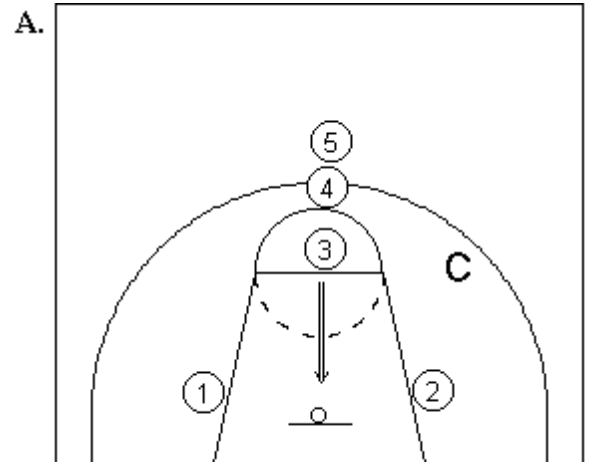

Basketball Drill

Drill Number: 29 **Name:** One On One
Type: Individual Offense, Defense

Description:

Players are in groups of three. Player 1 is passer, player 2 is offense, X2 is defense.

Player 2 gets open (V-cut, back cut, lead from post etc.), player 1 makes pass. X2 plays defense (deny pass, play defense one-on-one).

Offense must always square up and assume triple threat position when receiving on perimeter.

Offense can use any offensive move, or might be instructed to use certain one by coach. These might include,

- a) Catch, face and shoot.
- b) Jab step and shoot.
- c) Jab step, shot fake and shoot.
- d) Jab step and strong side drive into jump shot off dribble.
- e) Jab step and crossover drive into jump shot off dribble.
- f) Jab step and strong side drive into power layup.
- g) Jab step and crossover drive into power layup.

Players rotate X2 becomes passer, 2 becomes defense, 1 becomes offense.

Can have two groups at each basket.

Variations:

1. Only token defense if players need practice on moves.
2. Make X2 close out from a distance.
3. Use different positions on court.

Points of Emphasis:

1. Catch and face - triple threat.
2. Stay balanced.
3. Fool the defense with realistic jabs and shot fakes.
4. Read the defense - take what they give you.
5. Intensity - game pace.

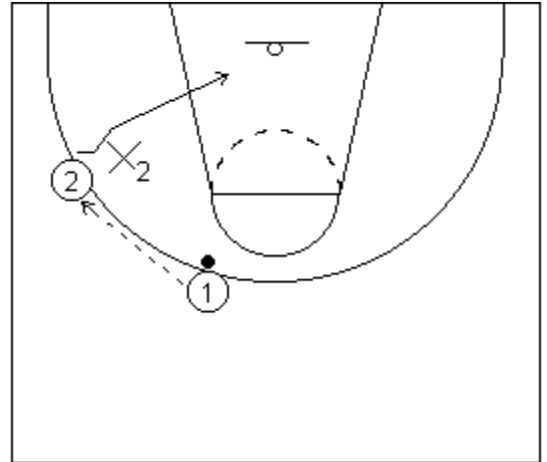

Basketball Drill

Drill Number: 30 **Name:** Pass, Shoot And Rebound
Type: Offense

Description:

Players operate in groups of three. One player is passer, one is rebounder (starts with ball), the other is shooter.

Rebounder passes to passer, passer passes to shooter, shooter shoots, rebounder rebounds and sequence is repeated.

Variations:

1. Run drill for certain time (say 1 minute) and rotate players.
2. Rotate every shot.
3. Shooter must dribble to right or left and shoot.
4. Shooter must relocate every shot.
5. Passer and shooter give shot fake, jab step etc. before pass or shot.

Points of Emphasis:

1. Correct shooting form.
2. Correct rebounding technique (chin ball, elbows protect, pivot away and pass)
3. Passer and shooter receive in ready position (be low).
4. Passer passes to "shooting pocket".

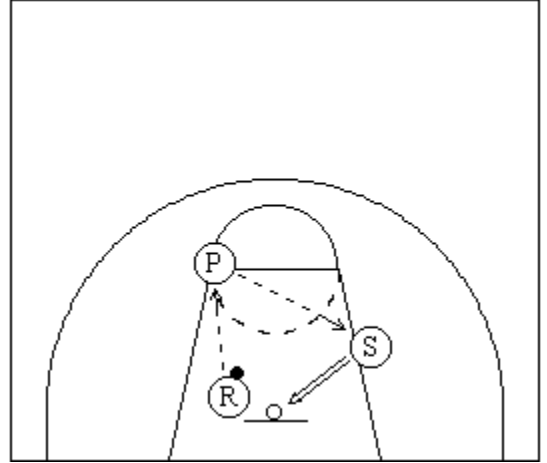

Basketball Drill

Drill Number: 31 **Name:** Pass, Shoot, Box Out
Type: Shooting, Boxing Out

Description:

Players are in pairs. Player 1 is on perimeter in shooting range, player 2 is under basket with ball.

Player 2 passes to player 1. Player 1 takes one strong dribble either side into a shot. Player 2 as soon as they pass the ball is closing out, trying to pressure the shot and boxing out once the shot is made.

Both players go for the rebound. If offense gets the rebound they should try and score.

Player that gets the rebound is offense on next repetition.

Variations:

Use different parts of the floor.
Have 2-3 pairs at each basket and use as many baskets as you have.

Points of Emphasis:

1. Correct shooting form.
2. Dribble to go somewhere.
3. Stay low and go up into the shot.
4. Close out properly.
5. Make contact on the box out.
6. Compete for the rebound.

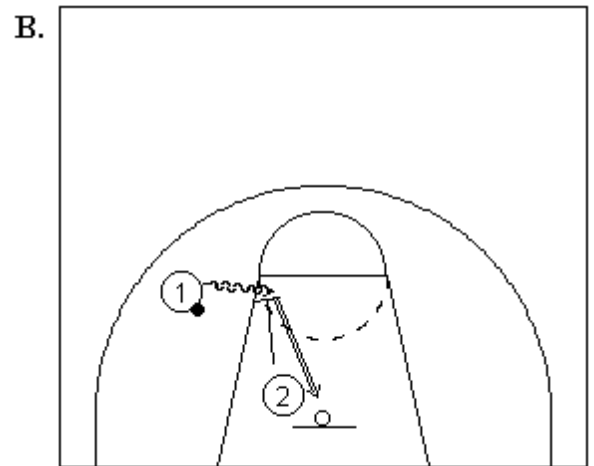
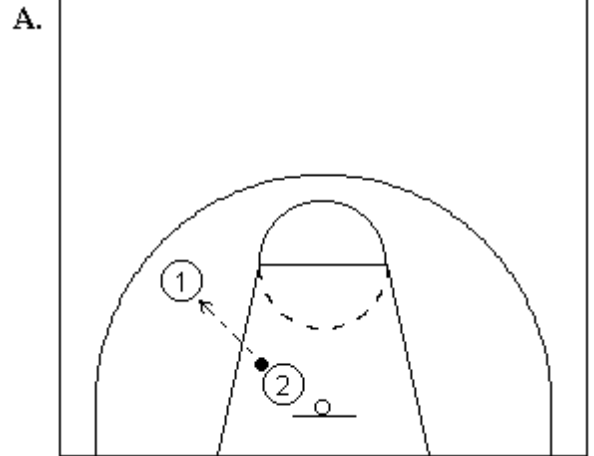

Basketball Drill

Drill Number: 32 **Name:** Penetrate And Dish
Type: Offense

Description:

This drill is designed to teach the skills of dribble penetration into the key and passing the ball to a teammate who have placed themselves in a good position.

The drill can be run from a 3 on 2 set (see diagram A & B), and can be run with the dribble penetration coming from any area of the offensive court (e.g. diagram A shows penetration from the point, diagram B shows penetration from the wing).

Diagram C shows one of the possible sets when running the drill 4 on 3.

Have the penetrating dribbler undefended with a defender on each of the other offensive players.

Dribble penetration should "split" two of the defenders. Receivers must read their defender and cut to an advantageous position. Dribbler should pass to best option but can continue drive to basket if defense sag off.

Variations:

1. 3 on 2, 4 on 3 or 5 on 4.
2. Run from all parts of floor.

Points of Emphasis:

1. Direct penetration between the defenders - attack the gaps.
2. Drive to score.
3. Get into the key (two feet in the key).
4. Receivers read the defense and the dribbler.
5. Receivers face dribbler in ready position.
6. Receivers cut to the basket.

A.

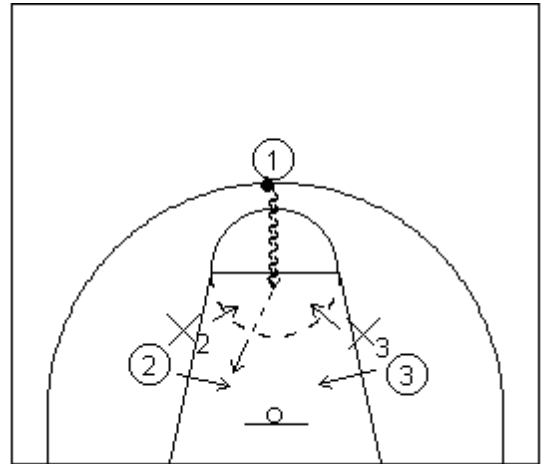

B.

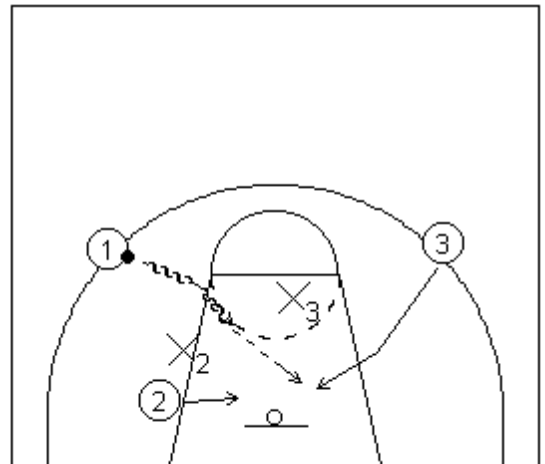

C.

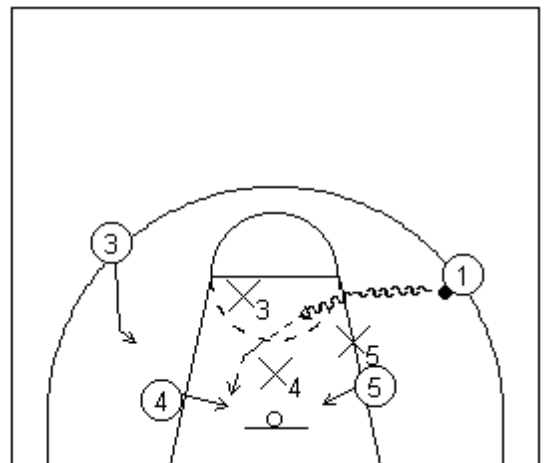

Basketball Drill

Drill Number: 33 **Name:** Pepper Drill
Type: Passing / receiving

Description:

Players form a semi-circle around one of the players.

Note that the player in the middle is a step inside the circle - this ensures she has to use her peripheral vision to see the players on the ends of the semi-circle.

The player in the middle and the player on one end each have a ball.

Player 1 passes to player 3 and then receives the pass from player 2.
Player 1 passes to player 4 and then receives the pass from player 3.

The play continues like this, and then returns in the opposite direction around the circle.

Players then rotate so each has a turn as the middle passer.

Variations:

1. Specify the types of passes to be made.
2. Make a rule that the middle passer must make a different type of pass than they just received.
3. Time each player for a certain number of rotations.

Points of Emphasis:

1. Good, hard passes.
2. Quickness (but don't hurry).
3. Show "ten fingers" to receive the ball.

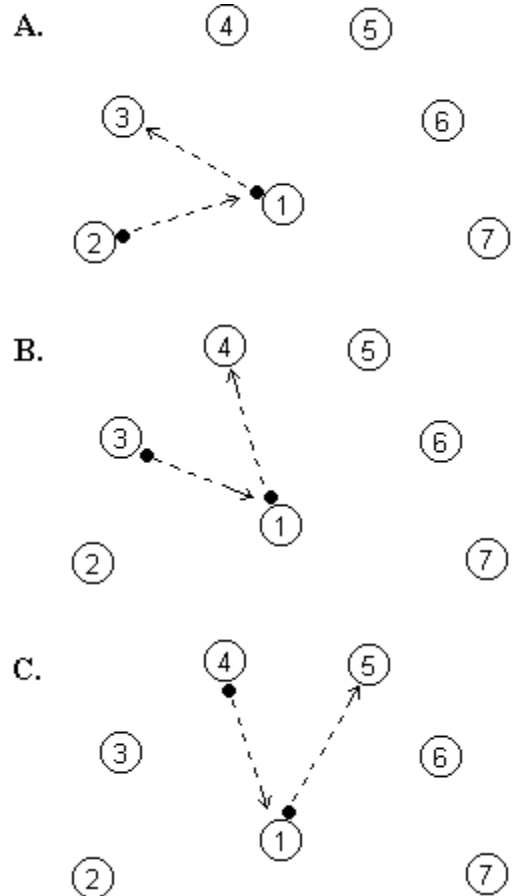

Basketball Drill

Drill Number: 34 **Name:** Pig In The Middle
Type: Passing, Defense

Description:

Players are in groups of three.

Players 1 and 2 stand about 3-4 metres apart with third player in between. They must make passes to each other while X1 attempts to get a hand on the ball.

X1 must play aggressive defense on ball handler, rather than sagging off.

As soon as X1 gets hand on ball he swaps position with the passer.

Variations:

Place time limit on passer (e.g. X1 counts to 3 seconds) and passer must pass the ball before time expires.

Points of Emphasis:

1. Fake a pass to make a pass.
2. Passer must attack the defender. Step into / around defender to make pass.
3. Defender must call "ball" every time.

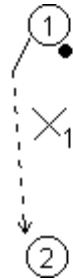

Basketball Drill

Drill Number: 35 **Name:** Pivot Away, Two On One
Type: Pivoting, Offense

Description:

Players form three lines at centre line.

Player in middle line receives pass from coach at free-throw line and one player from each of the other lines follow to play defense.

Player 1 with ball must keep ball away from the two defenders for 5 seconds by pivoting and ball movement. The end of the five second count is announced by the coach and the player tries to split the defenders and make a drive to basket.

Players return to a different line.

Variations:

After 5 second count player passes to coach.

Points of Emphasis:

1. Stay low and pivot aggressively.
2. Move ball strongly and vary position of ball up and down.
3. Strong step-through.
4. Good double-team technique by defenders.

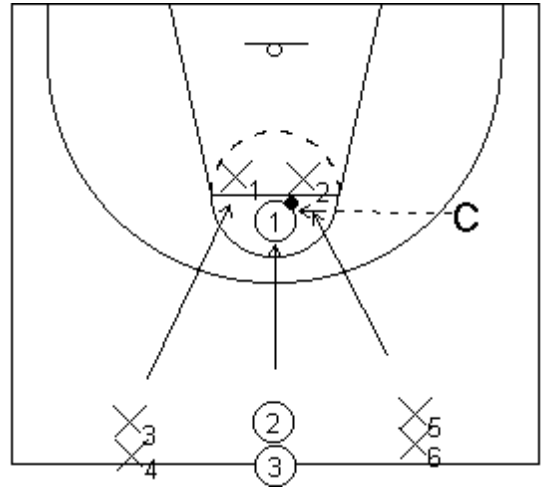

Basketball Drill

Drill Number: 36

Name: Post Moves

Type: Individual Offense, Defense

Description:

Players are in groups of three. Player 1 is perimeter passer, player 5 is offensive post, X5 is defensive post.

Player 5 posts up looking for pass from player 1.

Player 1 can dribble from wing to corner and back along three point line.

Post should attempt to post-up strong or seal defender if possible.

Upon receiving pass, post reads defense and makes appropriate move. This could include,

- a) Drop-step baseline into power lay-up.
- b) Drop-step middle into baby hook.
- c) Turn and face, bank shot.
- d) Turn and face, drive middle.
- e) Turn and face, up and under (crossover into power lay-up).

Post can pass back out if a good shot isn't available.

Players rotate X5 becomes perimeter passer, post offense becomes post defense, perimeter passer becomes post offense.

Use two groups at each basket.

Variations:

Token defense only for beginners (coach may instruct defender to overplay one side for offense to practice certain moves).

Points of Emphasis:

1. Jump stop when receive pass.
2. Chin ball, elbows out, low stance.
3. Read the defense - take what they give you.
4. Avoid rapid movement on offense, rather use your body and leverage to gain position.
5. Get body parallel to backboard for power-lay-up.
6. Go up strong, protect ball with inside arm / elbow.
7. Pump fake.
8. Slash arm, inside leg technique.
9. Defense half-front high or low depending upon position of ball. Correct footwork in front of offense post to change from one position to the other.

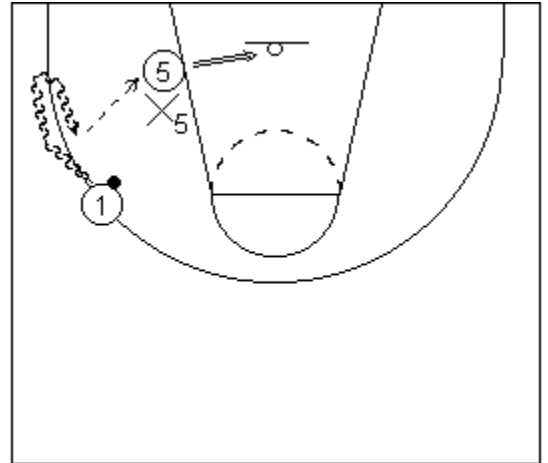

Basketball Drill

Drill Number: 37 **Name:** Power Post Pickups
Type: Power lay-ups

Description:

Two balls are placed on the low blocks.

One player is the post shooter, two other players are to rebound balls and place them back on the low blocks after each shot.

Post shooter starts in middle of lane and alternately picks up each ball off low block and makes post move to the basket (maximum of one power dribble allowed).

Players rotate positions after specified time.

Variations:

Specify types of move to be made (e.g. drop-step baseline into power lay-up, drop-step middle into baby hook etc.).
Most baskets in certain time (e.g. one minute).

Points of Emphasis:

1. Work hard.
2. Concentrate on footwork.
3. Get body parallel to backboard for power lay-ups.
4. Put the ball up strong with two hands well above the ring.

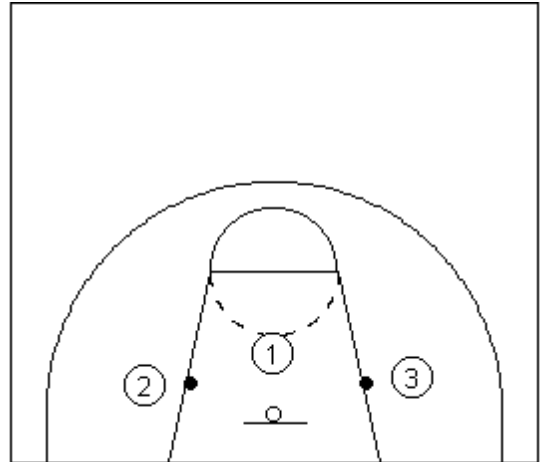

Basketball Drill

Drill Number: 38 **Name:** Pride Drill
Type: Transition, Conditioning

Description:

Drill starts with a five on zero offensive transition and score.

On score, all players sprint to defensive positions and get into defensive stance and execute "foot-fire" or defensive "pitter-patter" until coach passes one of them the ball when they return to offensive transition and repeat.

After two repetitions swap out to new team or bring in fresh players.

Variations:

Coach might award points for correct execution, hustle and effort. Players do drill until certain points score is reached.

Points of Emphasis:

1. On offense, fill the lanes.
2. On defense, sprint back while seeing the "ball".

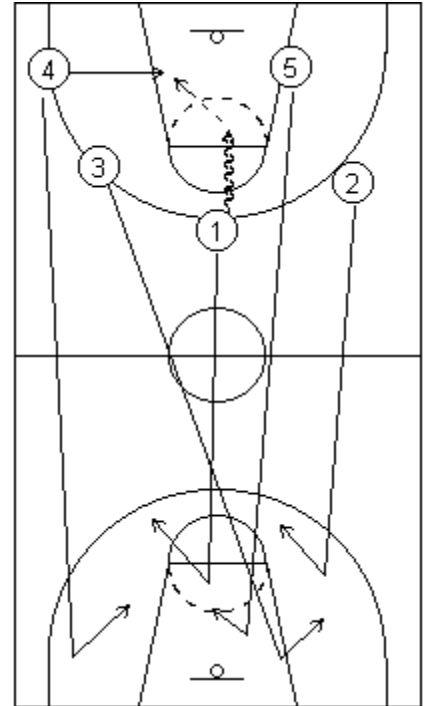

Basketball Drill

Drill Number: 39 **Name:** Shell Drill
Type: Team Defense

Description:

Four players assume offensive positions at guard and wing or corner positions. Four players assume defensive positions based on the following rules,

- If your man has the ball play him - push to sideline, no penetration.
- If your man is one pass away - play deny stance in passing lane.
- If your man is two passes away - play in the key in help position.
- If your man is more than two passes away - play on the split line in help position.

On ball movement all defensive players move to correct position.

On receiving pass offense must always catch and face.

When first teaching shell drill have offense hold ball for two-second count before passing.

Rotate offense to defense.

Variations:

The shell drill should be run in the following progression. Build up to latter stages over number of sessions.

- Stationary offense - defense allow passes. This stage is so defenders get used to movement into correct positions.
- Offense move (v-cuts and replace only) - defense allow passes.
- Offense move (v-cuts and replace only) - deny passes.
- Allow penetration only - defensive help.
- Allow offense to exchange positions.
- Allow screens.
- Live four-on-four.

Depending upon the defensive emphasis you may want high defenders to sag and guard against penetration rather than denying pass.

Points of Emphasis:

- Jump to the ball - as pass is made - not once it gets there - "fly with the ball".
- See the ball and your man - point your pistols.
- Stance, stance, stance, stance - low, low, low, low. Must be lower than the player you are guarding.
- Correct footwork - slides, drop step, close-outs.
- Three main jobs are pressure on pass or shot, stop penetration, help your team-mates.

A.

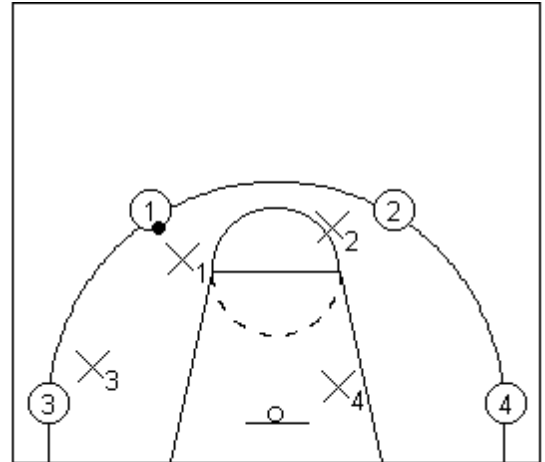

B.

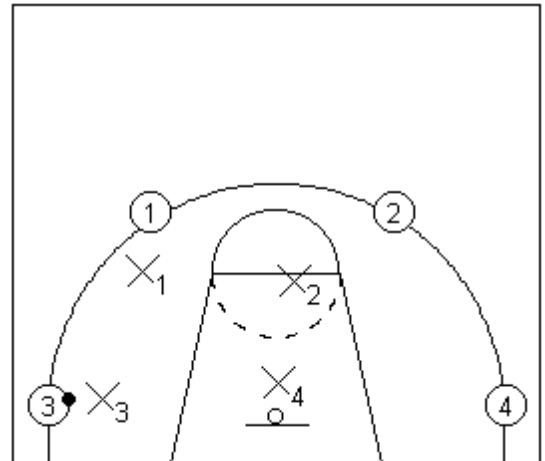

Basketball Drill

Drill Number: 40 **Name:** Slide Run Slide
Type: Defense

Description:

Players start at baseline facing out of court in defensive stance.

Players are playing against an "imaginary opponent" initially.

They begin by defensive sliding two or three steps then pretend they have been beaten and move to a run (sprint) to catch up, then return to defensive stance / slide, then repeat to other end of court.

Variations:

1. Add an opponent with ball rather than imaginary opponent.
2. Add an opponent moving without ball (harder for defence).
3. Defender holds towel behind back (concentrate on footwork).

Points of Emphasis:

1. Correct defensive footwork - stay low.
2. Sprint.
3. Effort.

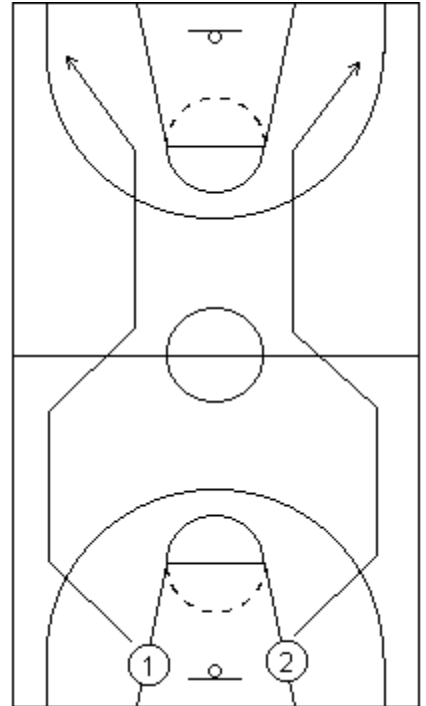

Basketball Drill

Drill Number: 41 **Name:** Star Drill
Type: Passing / receiving, lay-ups

Description:

Players line up as shown in diagram. Two players (3 & 4) are a step off each low free-throw lane position, two players (2 & 5) are a step off each elbow. The remaining players line up behind the baseline, the first person in line with a ball.

Player 1 passes to player 2 and follows her pass (taking 2's position).
Player 2 passes to player 3 and follows her pass.
Player 3 passes to player 4 and follows her pass.
Player 4 passes to player 5 and follows her pass.
Player 5 drives hard to the basket for lay-up, only one dribble (two for beginners) allowed.
Players rebound own shots and hand-off ball to next player in line, then move to the end of the line.

Drill continues in same manner.

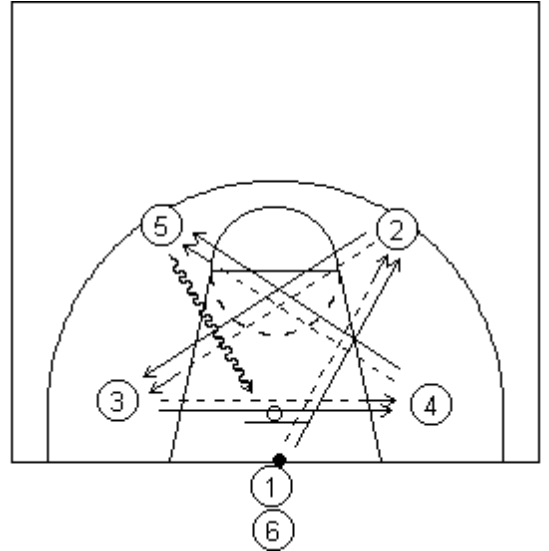

Variations:

1. Use two balls at once.
Enter second ball just after first ball is passed from position 3 to position 4.
2. Reverse the direction (for left-hand lay-ups).
3. Specify the type of pass to be made (e.g. chest, bounce, overhead).
4. Vary type of lay-up (e.g. reverse, two-foot stop into power lay-up etc.).
5. Take short jump-shot off dribble rather than lay-up.

Points of Emphasis:

1. All passes to be hard and accurate.
2. Call the passers name and "show ten fingers" to receive the ball.
3. Step forward to make, and receive the pass.
4. Hard drives to the basket with correct lay-up form.

Basketball Drill

Drill Number: 42 **Name:** Ten Fingers
Type: Cutting, Passing, Shooting

Description:

Players form two lines outside three-point line. All players, except for first in each line have a ball.

First players in each line run into key and v-cut back to ball.

Players "show ten fingers" and call to receive ball from next player in line. After receiving pass they square up to basket and either shoot, dribble / drive for lay-up or dribble into jump shot.

Passer can repeat move once shooter has gone to basket or shot the ball.

Players rebound their own balls and dribble back up court to end of lines. They are coming back through subsequent pairs who are completing drill (creating traffic).

Variations:

If full-court available, have players dribble to opposite end for a lay-up before they return to lines.

Points of Emphasis:

1. Plant foot and push off hard for good change of direction on cut.
2. Showing "ten fingers" and calling for ball.
3. Catch and face into triple threat.

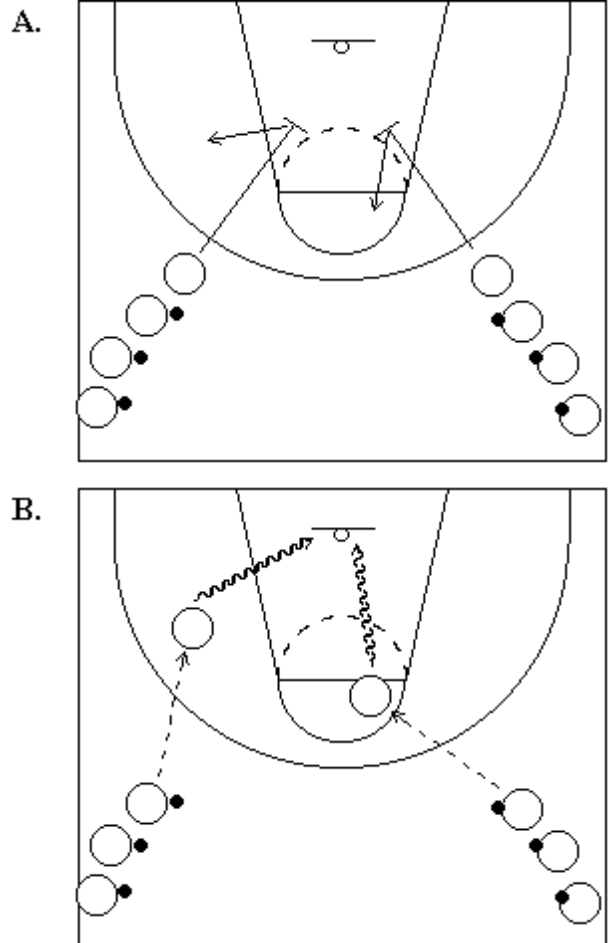

Basketball Drill

Drill Number: 43 **Name:** Terminator
Type: Dribbling

Description:

Vary the court space used depending upon the size of your group. For a group of eight to ten start off within the three-point line and baseline.

Each player has a ball and must dribble continuously within the designated area whilst trying to knock away the ball from other players.

Any player who cannot maintain their dribble or goes outside of the designated area is out and should step out of the designated area.

As number of players reduces further restrict the playing area (e.g. key, circle, top half of circle).

Last player left wins.

Variations:

Players only use weak hand to dribble.

Points of Emphasis:

1. Head up !
2. Correct dribbling technique - fingertip control - use the wrist - push the ball to the floor.
3. Low dribbling stance - protection stance.

Basketball Drill

Drill Number: 44 **Name:** Three On Two, Two On One
Type: Transition

Description:

Two players assume "tandem" defensive position at one end, all other players form 3 lines at baseline at opposite end. Player in middle line has ball.

Three players (first in each line) bring ball down court to play 3 on 2 versus the two defenders.

As soon as defenders get ball, or a score is made, the two defenders play 2 on 1 in the opposite direction against either,

- a) the shooter, in the case a shot was just taken (made or missed), or,
- b) the person who turned over the ball, in the case an interception was made, or violation occurred.

The other two offense remain to be defense for next three players.

Variations:

1. Have players throw ball off backboard, rebound ball and outlet to start drill rather than just running off lines.
2. Must make certain number of passes in transition.
3. Start next 3 coming down court while 2 on 1 is still coming back (create traffic).

Points of Emphasis:

- 1) Run lanes hard, cut to basket at free-throw line extended.
- 2) Sprint.
- 3) Correct defensive play of 3 on 2 situation, that is,
 - a) tandem alignment,
 - b) front defender takes ball,
 - c) rear defender takes first pass and front player drops.
- 4) Correct offensive play of 3 on 2 situation, that is
 - a) outside players stay wide and cut to basket,
 - b) ball-handler draw front defender
 - c) ball-handler make good pass to most open player and cut to ball-side elbow
- 5) Driving lane, passing lane concept.
- 6) Communicate (both offense and defense).
- 7) Take the ball to the basket hard.
- 8) On turnover get straight into offensive transition.
- 9) On made shot, step out of court and get in-bound pass in quickly, straight into offensive transition.

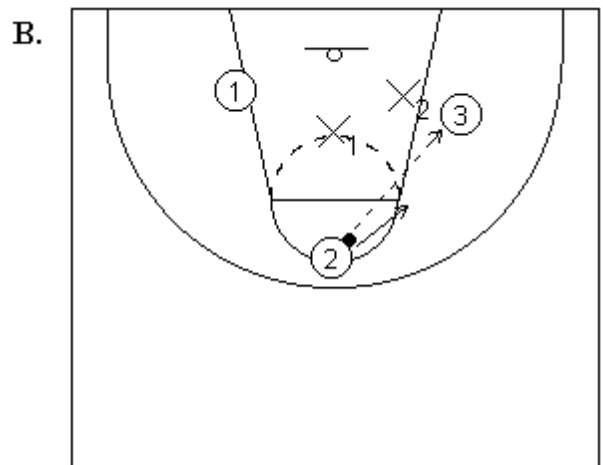
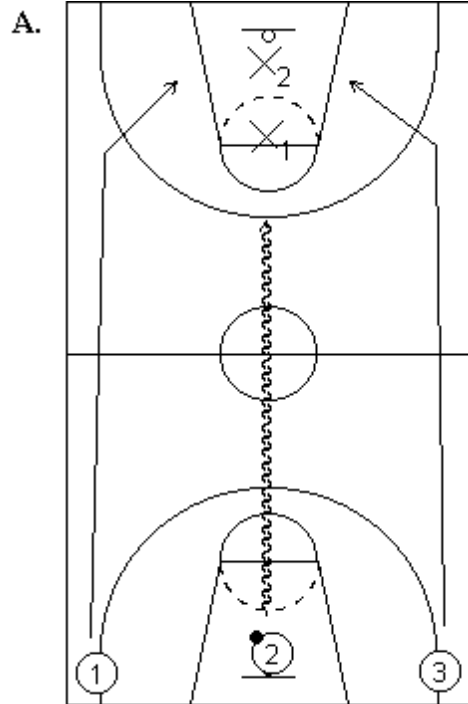

Basketball Drill

Drill Number: 45

Name: Three-Man Weave

Type: Offensive transition, passing / receiving.

Description:

Players form three lines at baseline. Player in middle line has ball.

Ball is passed in a weave pattern up the court. Players cut behind the person they have passed to (see diagram).

Player who receives ball near edge of offensive key makes a hard drive to basket. The other two players form a rebounding triangle and any missed shots are put back after the rebound.

After the made basket, the ball is grabbed, the player steps out of bounds and the drill is repeated back down the court.

Variations:

1. Players can wait at end of court (rather than coming back) for rest of players in line to come down court and then all take in turns to come back in opposite direction. This way, the next three players can start when the previous three cross halfway.
2. Specify the types of passes to be made.

Points of Emphasis:

1. Sprint down the court.
2. Run the lanes - go wide.
3. Communicate - call for the ball.
4. Pass in front of the moving player.
5. No travelling.
6. Ball does not hit the floor.

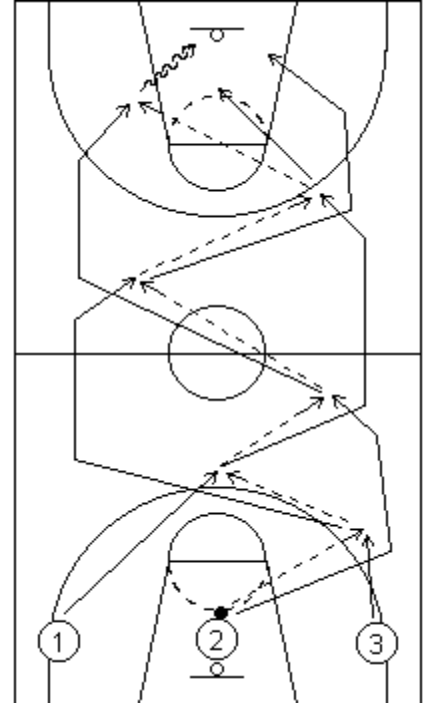

Basketball Drill

Drill Number: 46 **Name:** Turning And Channeling The Dribbler
Type: Individual Defense, Dribbling

Description:

Players in pairs, using both sides of the court.

One player in pair is on defense, she steps onto court with ball and hands offensive player the ball.

Each pair must stay on own side of the court.

Using good defensive stance and footwork to gain correct position, defensive attempts to turn the dribbler at least three times in the back court and then attempts to channel offensive player to the sideline in the front court.

Upon reaching end of court, both players sprint back to other end and rejoin line. Next time down, offense and defense swap places.

Swap groups to opposite sides of court halfway through allotted time.

Variations:

1. Initially defense should not attempt to get ball.
2. To stress footwork have defense play with hands holding towel behind back.
3. Add a third player to attempt trap at half-court line.

Points of Emphasis:

1. Correct defensive stance and footwork.
2. Nose to ball and overplay to turn dribbler.
3. Quickness.
4. Emphasis is on defensive position and footwork.
5. Dribbler - protect the ball.

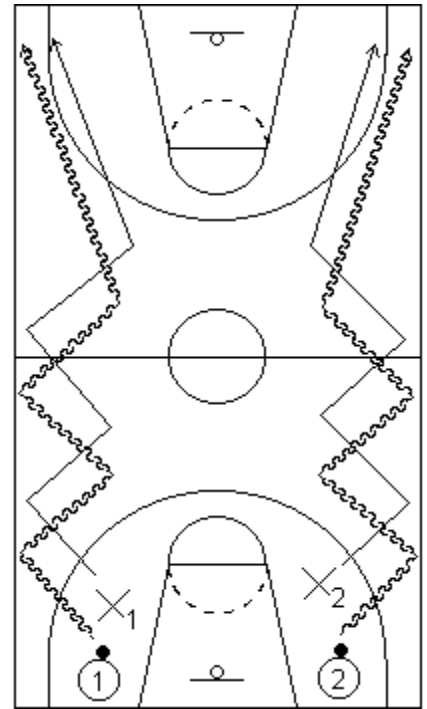

Basketball Drill

Drill Number: 47 **Name:** Two Teams Sliding
Type: Defense

Description:

Players line up, in two teams, along sideline as shown in diagram.

Alternately, each team slides across floor in a line and returns. When one team returns, other team goes.

To emphasize keeping low and defensive stance, players touch hands to floor between their legs 5 times and yell "defense" (at start, at opposite sideline, twice at mid-court - once on the way and once on the way back- and on return).

Players complete 180 degree pivot each time they cross split line.

Variations:

After a couple of repetitions, have players

1. Jump in air before touching floor.
2. Sprint from opposite sideline to mid-court on return leg.
3. Close-out from mid-court to opposite sideline.

Points of Emphasis:

1. Correct defensive stance and footwork.
2. Pure effort.
3. Teamwork - stay together.

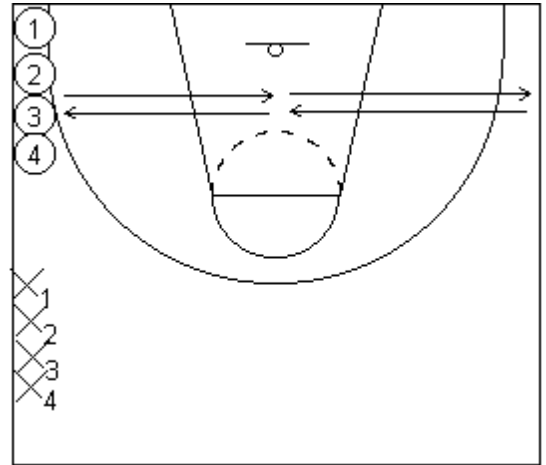

Basketball Drill

Drill Number: 48

Name: Cincinatti

Type: Passing, offensive transition

Description:

Players form two lines at half-court. One line in centre of court, the other near one sideline. One player is on free-throw line. First player in line at centre court must have ball.

First player in centre line (2), passes to player at free-throw line (1) whilst first player in side line (3) sprints the outside lane.

After receiving the pass, player (1) pivots and passes to (3) cutting to the basket. (3) receives pass and performs a lay-up.

(3) continues out opposite side of court while (1) rebounds the ball and outlets to (3) who takes one or two dribbles and passes to the next player in centre line who doesn't have a ball.

(3) goes to end of centre line, (1) goes to end of side line and (2) moves down to free-throw line to pass / rebound on next rotation.

Variations:

1. Move side-line to other side of court.
2. Use two or more balls.

Points of Emphasis:

1. Sprint the lane.
2. Drive the lay-up hard.
3. Pass the ball in front of the cutter so they don't have to stop.

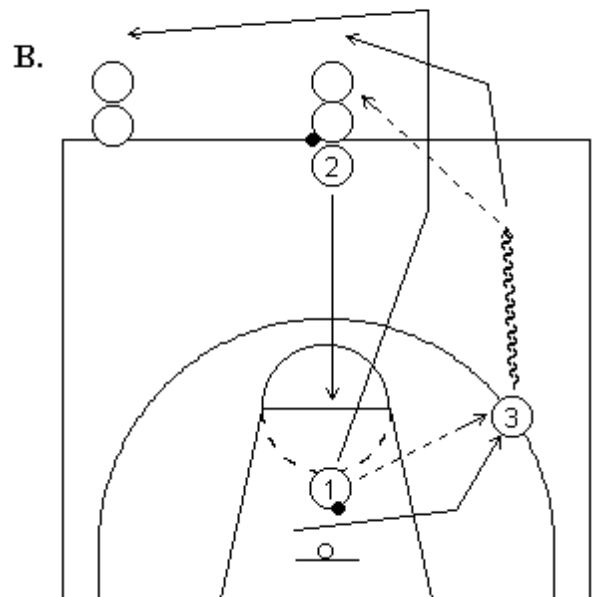
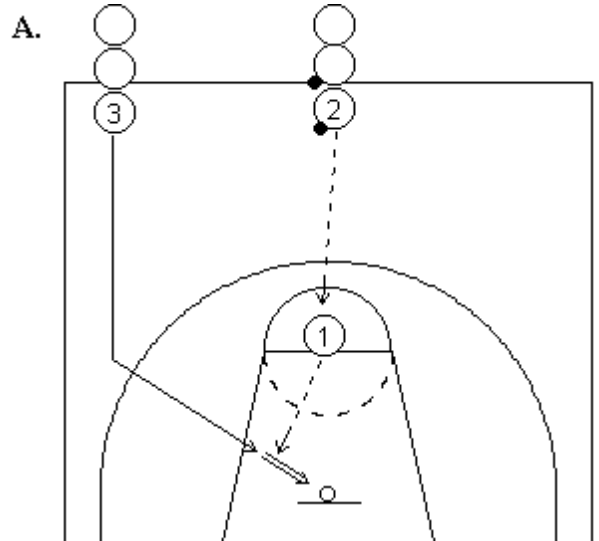

Basketball Drill

Drill Number: 49 **Name:** Create A Lead
Type: Offense

Description:

Players form four lines, two at each corner and two at half-court. First players in half-court lines have a ball.

Players in corner lines move to low post area and then "create a lead" (using the inside leg / inside arm technique).

After receiving the pass they face-up to the basket and make a one on one move to the basket.

Players rotate lines clockwise so all players get a turn at passing and receiving from both sides of the court.

Variations:

1. Use different one-on-one moves to the basket for both shots and lay-ups.
2. Use no-defense, then token defense, then real defense on players creating the lead. Then add token, then real defense to the passers as they become more accomplished.

Points of Emphasis:

1. Stress the cut to the basket to make the defender move.
2. Stress the correct inside leg, inside arm in front of the defender technique.
3. Players must face basket after receiving the pass.
4. Explosive one-on-one moves to the basket.

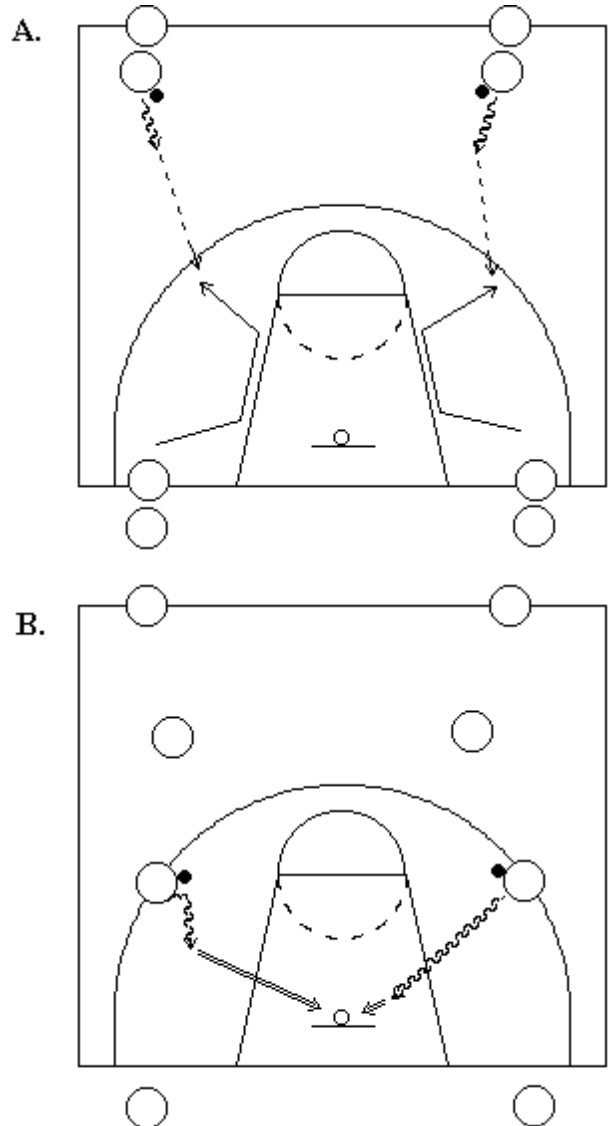

Basketball Drill

Drill Number: 50 **Name:** Dribble, Cut, Pass & Drive
Type: Offense

Description:

One player sets up on each low block. The remaining players line up at half-court. This line of players is behind coach who is standing on edge of centre circle, facing the basket.

Players in line dribble past the coach executing a stated move (hesitation, crossover, reverse etc.) as they pass the coach.

After the dribbler is past the coach, the coach signals to post players that one of them is to v-cut by holding out his left or right arm, or by establishing eye contact. Note this is not done until dribbler is past so he cannot see signal.

Nominated player executes a good v-cut and receives pass from dribbler. Player then makes move to basket (dribble to jump shot, drive for lay-up etc.).

Dribbler replaces post player who received pass. Post player who received pass goes to end of line.

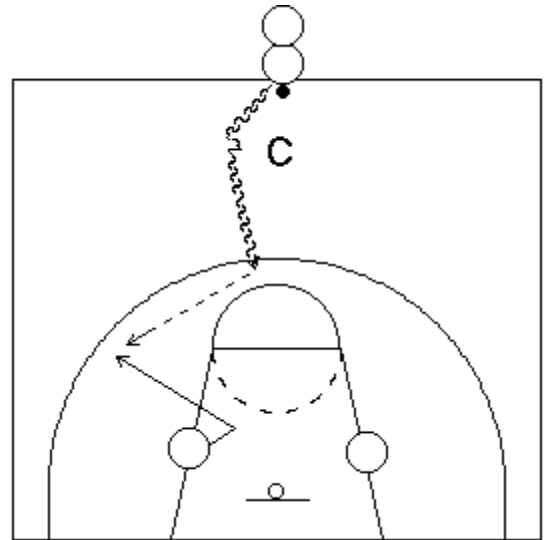

Variations:

Have other post player close out on receiver and play defence.

Points of Emphasis:

1. Good, hard cuts.
2. Timing of guard to wing pass.
3. Pass into "shooting pocket".
4. Hard drives to basket.

Basketball Drill

Drill Number: 52 **Name:** Triangle Passing
Type: Passing, Receiving

Description:

Players use half-court and form three lines. Two lines are at the half-court corners and the third is under the basket.

Players pass to player in next line, who is moving to the ball.
Players then move to the end of the line they have just passed to.

Variations:

1. Use two balls.
2. Change direction (go anti-clockwise).
3. On vocal command from coach players change direction during the drill.

Points of Emphasis:

Move to the ball to receive pass.
Show "ten fingers" and call passers name.
Sprint to the end of the line after passing.

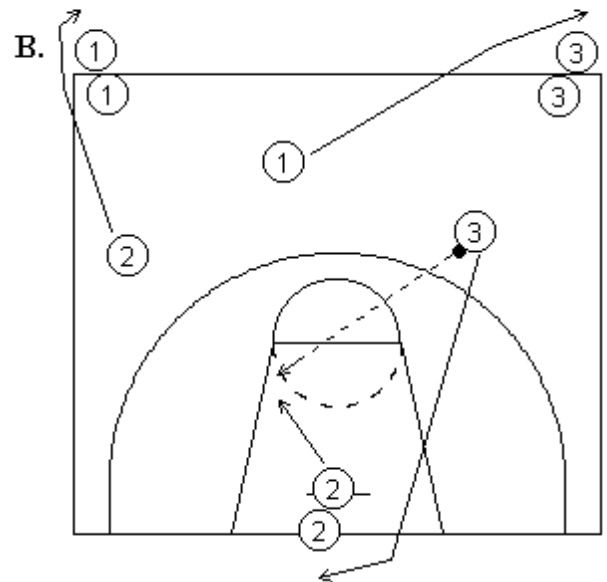
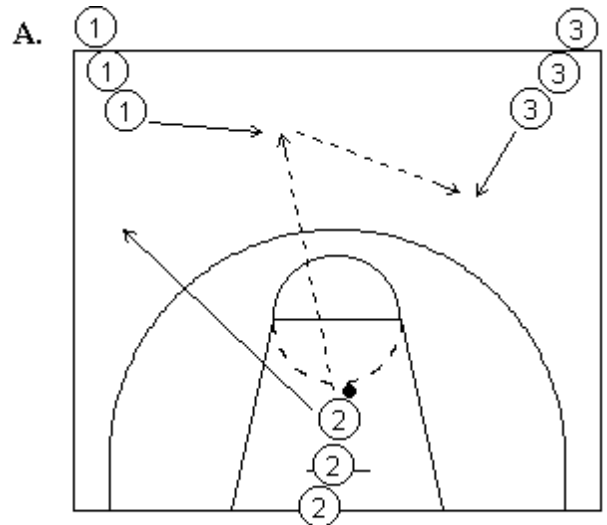

Basketball Drill

Drill Number: 53 **Name:** Triangle Shooting
Type: Shooting

Description:

Players form three lines around basket.

Players shoot and rebound their shots, pass to next in their line and return to end of line.

Rotate positions.

Variations:

1. Make it competitive by;
 - a) Seeing which team can make 10 (or any number) of shots first.
 - b) Seeing which team can make most shots from a set number.
2. Change distance of shot.

Points of Emphasis:

1. Correct shooting form.
2. Follow the shot and aggressively rebound.

